



CATALOGUE

FISHING LINES ACCESSORIES TACKLE BOXES

FOREWORD

Welcome to the new Relix Catalogue!

In this catalogue you will see many new ideas and innovations that our product development team has transformed from initial idea into finished product.

Relix have successfully installed and started the Fluoro Carbon line extrusion last year. We trust that Nylon, Fluoro Carbon and PE braided lines compliment each other and have their own unique function and character. Now we could serve our customers with a complete range of fishing line.

Want to maximise the strength of your PE? Relix Knot is the answer! By using Relix Knot for connecting PE to mono leader an angler can expect near 100% of the braided lines strength to be preserved allowing them to landed bigger fish with finer tackle and line.

For braided lines, we are now including the Japanese line number (号) as our standard PE line numbering, and for our international customers we retain the "i-Dia" information that gives an equivalent mono diameter. This helps with comparing lines and calculating spool capacities.

Keep innovating as perfection can never be achieved.

COMPANY PROFILE

Relix is a registered brand of P.T. Central Sarana Pancing, Indonesia.

- Company name : P.T. Central Sarana Pancing
Address : Jl. Raya Serang KM 12, Kawasan Industri Bunder No. 88
Kec. Cikupa Tangerang 15710, Banten Indonesia
Established : 1991
Manufacturing site :
 - ▣ Area : 148,413 sq ft or 13,788 sq m
 - ▣ Six factory buildings : injection & die casting building, reel factory, monofilament line factories and braiding line factory.
 - ▣ Facilities : innovations, research and state-of-the-art quality control laboratory, in-house photo studio, in-house graphic design department and on site testing fishing pond
Work force : 518 employees
Product range : Spinning reels, monofilament lines, braided lines, tackle boxes
Annual output :
 - ▣ 480 tons of fishing line
 - ▣ 140 million meters of PE Lines
 - ▣ 6,000 kg of Fluoro Carbon Line
 - ▣ 350,000 pcs of Spinning Reels
Customer base : over 50 countries globally



THE BEST INVENTIONS IN FISHING LINE INDUSTRY



P.T. Central Sarana Pancing
Designer and Manufacturer of Quality Fishing Tackle



CONTENTS

- 2 COMPANY PROFILE**
- 3 PHOTO GALLERY**
- 4 CONTENTS**

- 5 UNDERSTANDING RELIX BRAID**
- 6 BRAID**
- 11 NYLON**
- 15 FLUORO CARBON**
- 18 ACCESSORIES**
- 27 KNOTS**
- 29 INFORMATION**
- 33 TYPE OF SPOOLS**

FISHING LINES

- 37 DOUBLE SIDED BOXES**
- 38 MULTITRAY TACKLE BOXES**
- 39 LAYER TACKLE BOXES**
- 40 SYSTEM TACKLE BOXES**
- 41 LURE BOXES**
- 43 CLEAR TACKLE BOXES**
- 46 TACKLE STORAGE, FOLDING CONTAINER**
- 47 ROD RACK & ROD TUBE**

TACKLE BOXES- ROD RACK-ROD TUBE

UNDERSTANDING RELIX BRAID

PE Braided line is one of the best inventions in fishing line industry. It has increasingly become an important part of an angler's equipment. All this has been made possible by the invention of the Ultra High Molecular Weight Poly Etylene (UHMWPE, or simply PE) fiber: one of the strongest fibers in the world.

One weakness of PE braided lines that anglers quickly found out, is their low knot strength. With wrong type of knot, a braided line will loose considerably large part of its breaking strength. However, if proper knot is being used, this can easily be avoided, allowing the anglers to enjoy the world's strongest lines.

At RELIX laboratory, our R&D department has done a lot of research to find the most suitable knot for our braided lines. After hours and hours of work, we finally came up with a knot that is very suitable for connecting PE braided line to monofilament leader line. We proudly named it as the 'RELIX Knot'. We strongly recommend you to use the 'RELIX Knot' (page 27) for our braided lines.

Another important development in braided line is the application of special coating to improve abrasion resistance of the braid. Using proper coating, abrasion resistance of a braided line can be improved up to 8x that of common Nylon monofilament.

This is the 8th year of our collaboration with Chemours for the Teflon™ coating of our FANTASTIC 8 and FANTASTIC 4 PE Braids. The process of improvement is continually being carried out at RELIX to provide anglers with better and satisfactory products.

We have also amended our line specifications for braided lines. We are now including the Japanese line number (号) as our standard PE line numbering, and for our international customers we retain the "i-Dia" information that gives an equivalent to mono diameter. This helps with comparing lines and calculating spool capacities.

HS is a concept of a High Standard quality PE line for optimal fishing performance. Braided with continuous premium quality PE yarns in high stitches and then fortifying its strength with equalizing tension of each unit yarns. As a result, RELIX HS PE Line has optimal performance. Reliable, higher stability, higher abrasion resistance and longer life time, that is RELIX HS PE line.

ABOUT FANTASTIC SERIES

FANTASTIC SERIES is a perfect, universal braid. Constructed with premium PE yarns, braided line is undergoing special surface coating process with Teflon™ surface protector.

Coated with Teflon™ surface protector, its smoother surface enables longer casting distance and has an improved abrasion resistance and knot strength.



▲ FANTASTIC 8 HS - 8 Braid, High Stitches for Optimal Performance

ASIAN SPEC		INT'L SPEC						Yarns
No. #	Lb max	i-Dia	Lb	Kg	150m	300m	600m	
0.5	8.9	0.13	6	2.7	✓			8
0.6	11	0.14	8	3.6	✓	✓		
0.8	14	0.16	10	4.5	✓	✓	✓	
1.0	16	0.17	12	5.5	✓	✓	✓	
1.2	19	0.20	15	6.8	✓	✓	✓	
1.5	25	0.22	20	9.1	✓	✓	✓	
2.0	32	0.25	30	13.6	✓	✓	✓	
2.5	39	0.28	35	15.9	✓	✓	✓	
3.0	47	0.30	40	18.2	✓	✓	✓	
3.5	56	0.32	50	22.7	✓	✓	✓	
4.0	65	0.35	65	29.5	✓	✓	✓	
5.0	75	0.39	70	31.8	✓	✓	✓	
6.0	85	0.43	80	36.4		✓	✓	
8.0	105	0.49	100	45.5		✓	✓	
Parallel Winding					NO	NO	NO	
Type of Spool					D3	D3	G3	

▲ FANTASTIC 8 - 8 Braid, Longer Cast and more Silent

ASIAN SPEC		INT'L SPEC						Yarns
No. #	Lb max	i-Dia	Lb	Kg	150m	300m	600m	
0.5	8.9	0.13	6	2.7	✓			8
0.6	11	0.14	8	3.6	✓	✓		
0.8	14	0.16	10	4.5	✓	✓	✓	
1.0	16	0.17	12	5.5	✓	✓	✓	
1.2	19	0.20	15	6.8	✓	✓	✓	
1.5	25	0.22	20	9.1	✓	✓	✓	
2.0	32	0.25	30	13.6	✓	✓	✓	
2.5	39	0.28	35	15.9	✓	✓	✓	
3.0	47	0.30	40	18.2	✓	✓	✓	
3.5	56	0.32	50	22.7	✓	✓	✓	
4.0	65	0.35	65	29.5	✓	✓	✓	
5.0	75	0.39	70	31.8	✓	✓	✓	
6.0	85	0.43	80	36.4		✓	✓	
8.0	105	0.49	100	45.5		✓	✓	
Parallel Winding					NO	NO	NO	
Type of Spool					D3	D3	G3	

▲ FANTASTIC 4 HS - 4 Braid, High Stitches for Optimal Performance

ASIAN SPEC		INT'L SPEC						Yarns
No. #	Lb max	i-Dia	Lb	Kg	150m	300m	600m	
0.4	6.3	0.11	5	2.3	✓	✓		4
0.5	8.5	0.13	6	2.7	✓	✓		
0.6	9.8	0.14	8	3.6	✓	✓		
0.8	13.1	0.16	10	4.5	✓	✓	✓	
1.0	14.5	0.17	12	5.5	✓	✓	✓	
1.2	17.9	0.20	15	6.8	✓	✓	✓	
1.5	21.5	0.22	20	9.1	✓	✓	✓	
2.0	30.8	0.25	30	13.6	✓	✓	✓	
2.5	38.3	0.28	35	15.9	✓	✓	✓	
3.0	46.0	0.30	40	18.2	✓	✓	✓	
3.5	55.8	0.32	50	22.7	✓	✓	✓	
4.0	64.7	0.35	60	27.3	✓	✓	✓	
5.0	74.0	0.39	70	31.8	✓	✓	✓	
6.0	83.5	0.43	80	36.4	✓	✓	✓	
Parallel Winding					NO	NO	NO	
Type of Spool					D3	D3	G3	

▲ TINY HS - 3 Braid, Micro PE, High Stitches for Optimal Performance

ASIAN SPEC		INT'L SPEC						Yarns	
No. #	Lb max	i-Dia	Lbs	Kgs	150m	300m	600m		
0.22	5.2	0.09	3.5	1.6	✓	✓		3	
0.3	5.7	0.10	4	1.8	✓	✓			
0.4	6.3	0.11	5	2.3	✓	✓			
0.5	8.7	0.13	6	2.7	✓	✓	✓		
0.6	10.1	0.14	8	3.6	✓	✓	✓		
0.8	13.5	0.16	10	4.5	✓	✓	✓		
1.0	14.7	0.17	12	5.5	✓	✓	✓		
1.2	18.2	0.20	15	6.8	✓	✓	✓		
1.5	21.8	0.22	20	9.1	✓	✓	✓		
1.8	26.5	0.23	25	11.4	✓	✓	✓		
2.0	31.6	0.25	30	13.6	✓	✓	✓		
Parallel Winding					NO	NO	NO		
Type of Spool					A3	B1	D3		

▶ PRODUCT DESCRIPTIONS

FANTASTIC 8 HS line is designed simply for demanding anglers who want the best PE line. HS is a concept of optimizing braided line performance by applying a higher stitches braid on premium PE yarns and equalizing its yarns tension. Line will have higher stability, higher abrasion resistance and longer life time.

FANTASTIC 8 is universal 8 braided PE line coating with Teflon™ surface protector. Smoother surface enables longer casting distance, improved abrasion resistance and knot strength.

FANTASTIC 4 HS has been developed for advanced anglers too. Fantastic 4 HS is a 4-braided line with HS line optimizing concept. Fantastic 4 HS advantage is in its availability of finer size, less water absorption and its greater affordability. Although Fantastic 4 HS has less smooth surface compare to Fantastic 8, still offers high stability, higher abrasion resistance and longer life time.

FANTASTIC TINY HS is the best value for money item in Fantastic series. Fantastic Tiny HS excels in 'Tiny' size of PE line. Perfect for light fishing applications. Based on 3 yarns braided construction, Fantastic Tiny HS has an oval shape. Fantastic Tiny HS has high stability, higher abrasion resistance, longer life time and less strength drop in twist.

ABOUT RELIX 8 SERIES

The RELIX EIGHT BRAID SERIES are braided from 8 high quality PE yarns with a braid construction that is designed to give the best combination of suppleness and strength. It is soft as silk and very thin. X8 will cast further due to its suppleness. Practically no memory and zero stretch.



GERONG HS - 8 Braid, Ultimate Performance Braided Line

ASIAN SPEC		INT'L SPEC			150m	300m	600m	Yarns
No.#	Lb max	∅-Dia	Lb	Kg				
0.5	8.9	0.13	6	2.7	✓			8
0.6	11	0.14	8	3.6	✓	✓		
0.8	14	0.16	10	4.5	✓	✓	✓	
1.0	16	0.17	12	5.5	✓	✓	✓	
1.2	19	0.20	15	6.8	✓	✓	✓	
1.5	25	0.22	20	9.1	✓	✓	✓	
2.0	32	0.25	30	13.6	✓	✓	✓	
2.5	39	0.28	35	15.9	✓	✓	✓	
3.0	47	0.30	40	18.2	✓	✓	✓	
3.5	56	0.32	50	22.7	✓	✓	✓	
4.0	65	0.35	65	29.5	✓	✓	✓	
5.0	75	0.39	70	31.8	✓	✓	✓	
6.0	85	0.43	80	36.4	✓	✓	✓	
8.0	105	0.49	100	45.5		✓	✓	
Parallel Winding					NO	NO	NO	
Type of Spool					D3	D3	G3	



EIGHT BRAID - 8 Braid, All Round PE Line

ASIAN SPEC		INT'L SPEC			150m	300m	600m	Yarns
No.#	Lb max	∅-Dia	Lb	Kg				
0.5	8.9	0.13	6	2.7	✓			8
0.6	11	0.14	8	3.6	✓	✓		
0.8	14	0.16	10	4.5	✓	✓	✓	
1.0	16	0.17	12	5.5	✓	✓	✓	
1.2	19	0.20	15	6.8	✓	✓	✓	
1.5	25	0.22	20	9.1	✓	✓	✓	
2.0	32	0.25	30	13.6	✓	✓	✓	
2.5	39	0.28	35	15.9	✓	✓	✓	
3.0	47	0.30	40	18.2	✓	✓	✓	
3.5	56	0.32	50	22.7	✓	✓	✓	
4.0	65	0.35	65	29.5	✓	✓	✓	
5.0	75	0.39	70	31.8	✓	✓	✓	
6.0	85	0.43	80	36.4	✓	✓	✓	
8.0	105	0.49	100	45.5		✓	✓	
Parallel Winding					NO	NO	NO	
Type of Spool					D3	D3	G3	



JIGGING BRAID - 8 Braid with Length Indicator

ASIAN SPEC		INT'L SPEC			150m	300m	600m	Yarns
No.#	Lb max	∅-Dia	Lb	Kg				
0.5	8.9	0.13	6	2.7	✓			8
0.6	11	0.14	8	3.6	✓	✓		
0.8	14	0.16	10	4.5	✓	✓	✓	
1.0	16	0.17	12	5.5	✓	✓	✓	
1.2	19	0.20	15	6.8	✓	✓	✓	
1.5	25	0.22	20	9.1	✓	✓	✓	
2.0	32	0.25	30	13.6	✓	✓	✓	
2.5	39	0.28	35	15.9	✓	✓	✓	
3.0	47	0.30	40	18.2	✓	✓	✓	
3.5	56	0.32	50	22.7	✓	✓	✓	
4.0	65	0.35	65	29.5	✓	✓	✓	
5.0	75	0.39	70	31.8	✓	✓	✓	
6.0	85	0.43	80	36.4	✓	✓	✓	
8.0	105	0.49	100	45.5		✓	✓	
Parallel Winding					NO	NO	NO	
Type of Spool					D3	D3	G3	

PRODUCT DESCRIPTIONS

X8 GERONG HS – 8 Braid, High Stitches for optimal performance.

Line is designed for demanding anglers who want the best PE line.

EIGHT BRAID – RELIX EIGHT BRAID is a well balanced 8 braid that is perfect for all fishing applications that require thin and soft line such as vertical jigging, trolling, jerk bait, popping and spin fishing.

JIGGING BRAID 8 Braid Jigging series is an all-round 8 braid with additional length indicator feature to allow anglers having a better control of the line.



▶ EIGHT SINK2 - 8 Braid, Tuned Gravity Of 1.4 Range For Faster Sinking

ASIAN SPEC		INT'L SPEC			150m	300m	600m	Yarns
No. #	Lb max	∅-Dia	Lb	Kg				
1.2	9	0.20	8	3.6	✓	✓		8
1.5	16	0.22	10	4.5	✓	✓		
1.8	19	0.23	15	6.8	✓	✓		
2.0	21	0.25	18	8.2	✓	✓	✓	
2.5	25	0.28	20	9.1	✓	✓	✓	
3.0	32	0.30	25	11.4	✓	✓	✓	
4.0	39	0.35	30	13.6	✓	✓	✓	
5.0	47	0.39	40	18.2	✓	✓	✓	
5.5	56	0.41	50	22.7	✓	✓	✓	
6.0	65	0.43	60	27.3	✓	✓	✓	
Parallel Winding					NO	NO	NO	
Type of Spool					D3	D3	G3	

▶ EIGHT HYBRID SINK - 8 Braid, Affordable Sinking Braided Line Gravity of 1.2 Range

ASIAN SPEC		INT'L SPEC			150m	300m	600m	Yarns
No. #	Lb max	∅-Dia	Lb	Kg				
1.0	6.3	0.17	6	2.7	✓	✓		8
1.2	9.8	0.20	8	3.6	✓	✓		
1.5	13.1	0.22	10	4.5	✓	✓	✓	
2.0	14.5	0.25	12	5.5	✓	✓	✓	
2.2	17.9	0.26	15	6.8	✓	✓	✓	
2.5	21.5	0.28	20	9.1	✓	✓	✓	
3.0	30.8	0.30	25	11.4	✓	✓	✓	
4.0	38.3	0.35	30	13.6	✓	✓	✓	
5.0	46.0	0.39	40	18.2	✓	✓	✓	
5.5	55.8	0.41	50	22.7	✓	✓	✓	
6.0	64.7	0.43	60	27.3	✓	✓	✓	
Parallel Winding					NO	NO	NO	
Type of Spool					D3	D3	G3	

▶ QUICK SINK - Very Fast Sinking Aramid Fiber Braid. Gravity Index Of 1.38

ASIAN SPEC		INT'L SPEC			150m	300m	600m	Yarns
No. #	Lb max	∅-Dia	Lb	Kg				
0.5	0.13	5	2.3				✓	3
0.8	0.16	8	3.6				✓	
1	0.17	10	4.5				✓	
2	0.25	15	6.8	✓			✓	4
2.5	0.28	20	9.1	✓			✓	
3	0.30	25	11.4	✓			✓	
4	0.35	30	13.6	✓	✓		✓	
5.5	0.41	40	18.2	✓	✓		✓	6
6	0.43	50	22.7	✓	✓		✓	
7	0.46	60	27.3		✓		✓	8
8	0.49	80	36.4					
10	0.54	100	45.5					
11	0.57	150	68.2					
Parallel Winding					NO	NO	NO	
Type of Spool					D3	D3	G3	

▶ PRODUCT DESCRIPTIONS

EIGHT SINK2 is made of X8 PE yarns with PTFE heavy core. EIGHT SINK2 is slim and strong yet heavy. Built for demanding anglers. With gravity index of range 1.4 gr/cm³, EIGHT SINK2 arrives to the bottom faster than other braided lines.

HYBRID SINK is an 8 braided sinking line built at affordable price, suitable for all round fishing that requires sinking line like carp fishing, feeder fishing and float fishing. With X8 construction, HYBRID SINK will cast further due to its suppleness.

QUICK SINK is the fast sinking braid with high strength and high abrasion resistance. Quick Sink is made of 100% Aramid fiber, soft and very strong. The fast sinking property of RELIX QUICK SINK shortens the time it takes to tighten line after casting.

RELIX QUICK SINK is a fantastic line for medium heavy or heavy feeder fishing. This line is also perfect for carp fishing with boilie. Of course, anglers can also use this line for any type of fishing that requires very fast sinking.



BRAID 12 - Smoother and Stronger Semi Splice-able PE Line

ASIAN SPEC		INT'L SPEC						Yarns
No. #	Lb max	i-Dia	Lb	Kg	150m	300m	600m	
1	15.2	0.17	12	5.5	✓	✓		12
1.2	19.0	0.20	15	6.8	✓	✓		
1.5	22.3	0.23	20	9.1	✓	✓		
2	36.5	0.25	30	13.6	✓	✓	✓	
2.5	40.9	0.28	40	18.2	✓	✓	✓	
3	50.5	0.30	50	22.7	✓	✓	✓	
4	63.5	0.35	65	29.5	✓	✓	✓	
5	79.7	0.39	70	31.8	✓	✓	✓	
6	85.9	0.43	80	36.4	✓	✓	✓	
8	114.0	0.49	100	45.5	✓	✓	✓	
10	129.6	0.54	120	54.5	✓	✓	✓	
Parallel Winding					NO	NO	NO	
Type of Spool					D3	D3	G3	

SAMSON - Hollow PE. Fish with 100% Max Strength

ASIAN SPEC		INT'L SPEC						Yarns	
No. #	Lb max	i-Dia	Lb	Kg	150m	300m	600m		
2.5	42	0.28	40	18.2	✓	✓	✓	16	
3	50	0.30	45	20.5	✓	✓	✓		
4	65	0.35	50	22.7	✓	✓	✓		
5	80	0.39	65	29.5	✓	✓	✓		
6	87	0.43	80	36.4	✓	✓	✓		
7	96	0.46	90	40.9	✓	✓	✓		
8	115	0.49	100	45.5	✓	✓	✓		
10	130	0.54	120	54.5	✓	✓	✓		
Parallel Winding					NO	NO	NO		
Type of Spool					D3	D3	G3		

PRODUCT DESCRIPTIONS

BRAID 12 is 100% PE braided line built for professional anglers. BRAID 12 is superior to X8, it has higher suppleness and smoother surface, allowing longer cast. It's an all-round premium PE line.

SAMSON X16 allows splicing connection of PE line to a leader. With splicing connection, anglers could get 100% of PE strength. Samson X16 PE line is suitable for the most demanding anglers.

HOW TO CONNECT INTO HOLLOW BRAID

Connecting Fluoro/Mono into Hollow

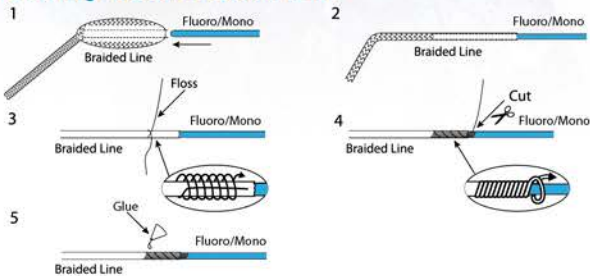

No. PE X16	Hollow Lb Test	Recommended Mono/Fluoro Lb Test	Recommended Mono/Fluoro Diameter (mm)
2,5	42	30 - 40	0.50 - 0.55
3	50	40 - 60	0.55 - 0.70
4	65	50 - 70	0.60 - 0.80
5	80	60 - 90	0.70 - 0.85
6	87	80 - 100	0.85 - 0.90
7	96	80 - 110	0.85 - 0.95
8	115	100 - 150	0.90 - 1.10
10	130	110 - 210	0.95 - 1.30

Whip a Loop in Hollow by using splicing needle

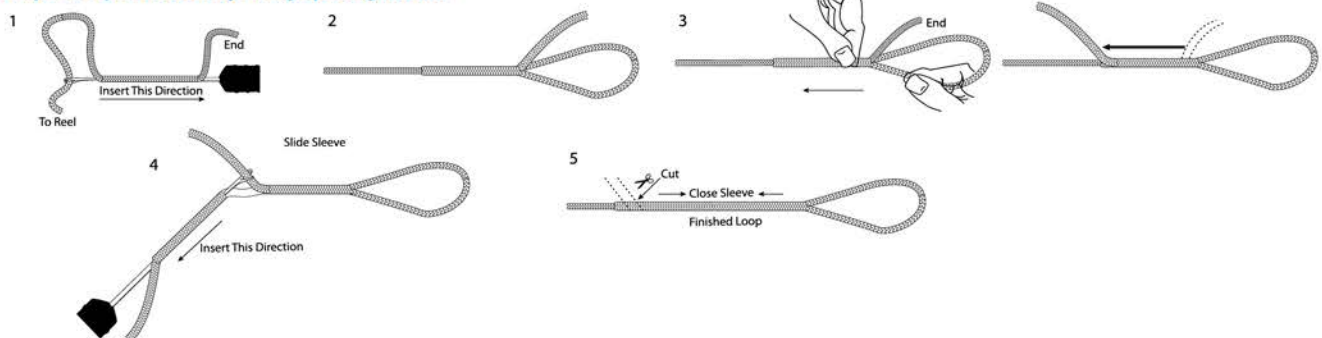

Hollow to Hollow connection by using splicing needle

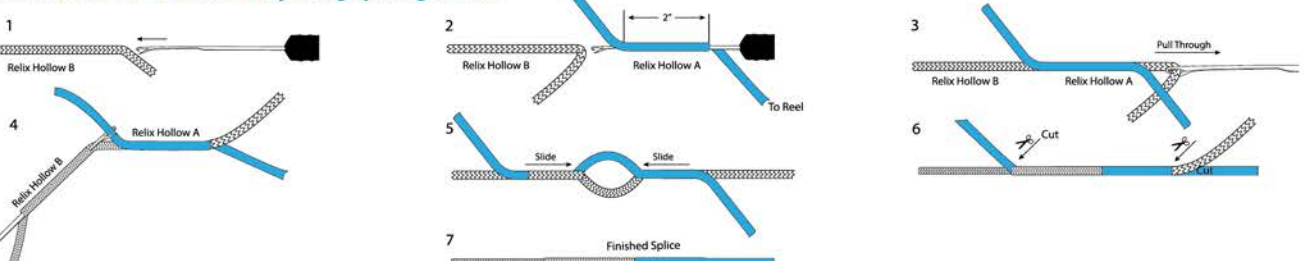



FOUR BRAID - 4 Braid, All Round PE Line

ASIAN SPEC		INT'L SPEC			150m	300m	600m	Yarns
No. #	Lb max	Ø-Dia	Lb	Kg				
0.4	6.3	0.11	5	2.3	✓	✓		4
0.5	8.5	0.13	6	2.7	✓	✓		
0.6	9.8	0.14	8	3.6	✓	✓		
0.8	13.1	0.16	10	4.5	✓	✓	✓	
1.0	14.5	0.17	12	5.5	✓	✓	✓	
1.2	17.9	0.20	15	6.8	✓	✓	✓	
1.5	21.5	0.22	20	9.1	✓	✓	✓	
2.0	30.8	0.25	30	13.6	✓	✓	✓	
2.5	38.3	0.28	35	15.9	✓	✓	✓	
3.0	46.0	0.30	40	18.2	✓	✓	✓	
3.5	55.8	0.32	50	22.7	✓	✓	✓	
4.0	64.7	0.35	60	27.3	✓	✓	✓	
5.0	74.0	0.39	70	31.8	✓	✓	✓	
6.0	83.5	0.43	80	36.4	✓	✓	✓	
Parallel Winding					NO	NO	NO	
Type of Spool					D3	D3	G3	

PRODUCT DESCRIPTIONS

FOUR BRAID constructed from 4 pcs of PE yarns. Four braid is as strong as X8, but offers wider range of finer size PE braided. Four braid is less surface smooth compare to X8. The best value for money braid in the range.

COLOR CHART FOR ALL RELIX BRAIDED LINE

Yellow	Dark Green	Dark Brown	Orange	Green	Olive Green	Black
Moss Green	Mud Brown	Grey	Fluo Yellow	Blue	Pink	Aramid
Purple	Fluo Green					
Multi Color 1		Multi Color 2				
Jig 1			Jig 2			

ABOUT RELIX 3GEN MONOFILAMENT

RELIX 3GEN (third generation) lines are extruded from terpolymer Nylon. Terpolymer consists of three different types of Nylon namely 6, 66 and 12. This new blend has the advantage of increased strength and better knot strength compared to the already advanced Nylon copolymer material, which consists of Nylon 6 and Nylon 66. Other characteristics, such as softness, are also improved by using 3Gen technology. You can fish with thinner line and pull harder with RELIX 3GEN line than with other lines from our competitors, and they last longer!

There are 3 different RELIX 3GEN series to choose from: Duranium, Max Power and Tiny. Extremely high abrasion resistance makes Duranium one of the toughest lines in the world. Relix Max Power is first of all very strong, also on the knots, and yet it is also soft, too. Relix Tiny is one of the thinnest lines in the world. It starts at 0.04 mm up to 0.20 mm.

Available Colors:



3GEN DURANIUM - Strongest Monofilament with 8x Abrasion Resistance

Dia	Lb	Kg	150m	300m
0.12	3	1.4	✓	
0.15	5	2.3	✓	
0.18	8	3.6	✓	
0.20	10	4.5	✓	✓
0.22	12	5.5	✓	✓
0.25	15	6.8	✓	✓
0.28	17	7.7	✓	✓
0.30	20	9.1	✓	✓
0.33	22	10.0	✓	✓
0.35	25	11.4	✓	✓
0.40	30	13.6	✓	✓
0.45	40	18.2		✓
0.50	45	20.5		✓
0.55	50	22.7		✓
0.60	60	27.3		✓
Parallel Winding			YES	YES
Type of Spool			C1	D2

Available Colors:



3GEN MAX POWER - Strongest Monofilament, Soft and Good Knot Strength

Dia	Lb	Kg	150m	300m	500m
0.12	3	1.4	✓		✓
0.15	5	2.3	✓		✓
0.18	8	3.6	✓		✓
0.20	10	4.5	✓	✓	✓
0.22	12	5.5	✓	✓	✓
0.25	15	6.8	✓	✓	✓
0.28	17	7.7	✓	✓	✓
0.30	20	9.1	✓	✓	✓
0.33	22	10.0	✓	✓	✓
0.35	25	11.4	✓	✓	✓
0.40	30	13.6	✓	✓	✓
0.45	40	18.2		✓	✓
0.50	45	20.5		✓	✓
0.55	50	22.7		✓	✓
0.60	60	27.3		✓	✓
Parallel Winding			YES	YES	NO
Type of Spool			C1	D2	D2

Available Colors:



3GEN TINY - Finest Nylon Monofilament

Dia	Lb	Kg	100m
0.04	0.8	0.4	✓
0.05	1.1	0.5	✓
0.06	1.4	0.6	✓
0.07	1.7	0.8	✓
0.08	2.1	1.0	✓
0.10	2.8	1.3	✓
0.12	3.8	1.7	✓
0.14	4.7	2.1	✓
0.16	6.5	3.0	✓
0.18	8.0	3.6	✓
0.20	10.0	4.5	✓
Parallel Winding			YES
Type of Spool			A1

PRODUCT DESCRIPTIONS

3GEN DURANIUM is suitable for catching big fish with teeth that requires highly abrasion resistant lines. It is ideal for fishing in waters with many obstacles or structures such as snag, rock, twigs, weed beds and of course jiggling over shipwrecks. Suitable for fishing big fish with teeth such as pike or bass. Also recommended for feeder fishing.

3GEN MAX POWER is perfect for fishing that requires soft but extremely strong monofilament line. Very suitable for carp fishing with boilies and spinning fishermen with baitcasting reels.

3GEN TINY has very high strength to size ratio and still retains very high knot strength and softness. Anyone comparing breaking strength of RELIX 3GEN TINY will understand why many freshwater competition fishermen prefer RELIX 3GEN TINY. It is very strong and therefore an absolute winner! Also ideal for casting competitions and ice fishing.

Available Colors:



▶ BEST BALANCE - Best Performance All Round Fishing Line

Dia	Lbs	Kgs	100m	150m	300m
0.14	3	1.4	✓	✓	
0.16	4	1.8	✓	✓	
0.18	5	2.3	✓	✓	
0.20	6	2.7	✓	✓	✓
0.23	8	3.6	✓	✓	✓
0.26	10	4.5	✓	✓	✓
0.28	12	5.5	✓	✓	✓
0.30	15	6.8	✓	✓	✓
0.33	18	8.2	✓	✓	✓
0.35	20	9.1	✓	✓	✓
0.40	25	11.4	✓	✓	✓
0.45	30	13.6	✓	✓	✓
0.50	40	18.2	✓	✓	✓
0.60	50	22.7	✓		
0.65	60	27.3			
0.70	70	31.8			
Parallel Winding Type of Spool			NO B1	NO B1 D1	NO D1

Available Colors:



▶ FLEXUS - Extra Soft Monofilament Line

Dia	Lbs	Kgs	150m	300m
0.15	3	1.4	✓	
0.18	5	2.3	✓	
0.20	6	2.7	✓	✓
0.22	8	3.6	✓	✓
0.25	10	4.5	✓	✓
0.28	12	5.5	✓	✓
0.30	15	6.8	✓	✓
0.33	18	8.2	✓	✓
0.35	20	9.1	✓	✓
0.40	25	11.4	✓	✓
0.45	30	13.6		✓
0.50	40	18.2		✓
0.60	50	22.7		✓
0.65	60	27.3		
0.70	70	31.8		
Parallel Winding Type of Spool			YES C1 D1	YES D1

Available Colors:



▶ MEMORIX - No Memory and Excellent Shock Absorption

Dia	Lbs	Kgs	150m	300m
0.15	3	1.4	✓	
0.18	5	2.3	✓	
0.20	6	2.7	✓	✓
0.22	8	3.6	✓	✓
0.25	10	4.5	✓	✓
0.28	12	5.5	✓	✓
0.30	15	6.8	✓	✓
0.33	18	8.2	✓	✓
0.35	20	9.1	✓	✓
0.40	25	11.4	✓	✓
0.45	30	13.6		✓
0.50	40	18.2		✓
0.60	50	22.7		✓
0.65	60	27.3		
0.70	70	31.8		
Parallel Winding Type of Spool			YES C1 D1	YES D1

▶ PRODUCT DESCRIPTIONS

BEST BALANCE has the best possible balance of all distinctive characteristics. It is the best all-round line we can offer and maybe even the best all-round fishing line available in the market. Once introduced to a specific market, it is always well received by the fishermen, who stay loyal to it. RELIX BEST BALANCE has been our bestselling line for years.

RELIX BEST BALANCE is suitable for the widest possible range of different fishing techniques. In practice it has proven to be very popular among carp, catfish and bass fishermen. Also perfect for sea fishing because of its overall superior performance. We improve it continuously through our extensive R&D.

FLEXUS is a super soft line that will stay soft, even after extensive usage, because of the special material blend and treatments during production. The special additive will not disperse in the water during usage as with other soft lines. Fish will not detect it easily because of its softness. It also allows sport fishermen to cast much farther!

RELIX FLEXUS is ideal for presentation of bait to sensitive fish, such as walleye or carp. It can absorb the explosive power of a violent attack of aggressive predators, such as bass, walleye, pike or sea bass because of its higher shock absorption property. Recommended for spin fishing, because it allows casting farther, and for ice fishing because it stays soft in cold temperature.

MEMORIX is a very low memory line that will not tangle but ensure direct connection between your rod and bait after the cast. It is also very soft, and the knot strength is outstanding!

RELIX MEMORIX is suitable for fishing with live baits and predatory fishing. RELIX MEMORIX is perfect for pole fishing too because of its softness and high elongation.

Dia (mm)	0.14	0.16	0.18	0.20	0.23	0.26	0.28	0.30	0.33	0.35	0.40	0.45	0.50	0.60	0.65	0.70
#1/8(m)	2.976	2.279	1.800	1.591	1.203	941	812	707	584	519	398	314	255			
#1/4(m)				2.917	2.205	1.726	1.488	1.296	1.071	952	729	576	467	324	276	238
(m)/1kg	54.100	41.400	32.700	26.500	20.000	15.600	13.500	11.700	9.739	8.658	6.629	5.238	4.242	2.946	2.510	2.165

Reference for Best Balance / Flexus / Memorix / Coral

Available Colors:



► **CORAL** - Highly Abrasion Resistance Monofilament Line

Dia	Lbs	Kgs	150m	300m	
0.14	3	1.4	✓		
0.16	4	1.8	✓		
0.18	5	2.3	✓	✓	
0.20	6	2.7	✓	✓	
0.22	8	3.6	✓	✓	
0.25	10	4.5	✓	✓	
0.28	12	5.5	✓	✓	
0.30	15	6.8	✓	✓	
0.33	18	6.2	✓	✓	
0.35	20	9.1	✓	✓	
0.40	25	11.4	✓	✓	
0.45	30	13.6		✓	
0.50	40	18.2	✓	✓	
0.60	50	22.7	✓	✓	
0.65	60	27.3			
0.70	70	31.8			
Parallel Winding Type of Spool			YES C1	YES D2	YES D2

Available Colors:



► **SEA MARK** - 8x Abrasion Resistance Sea Fishing Line

Dia	Lbs	Kgs	300m	600m
0.36	18	8.2		✓
0.40	20	9.1		✓
0.45	25	11.4		✓
0.50	30	13.6		✓
0.55	40	18.2		✓
0.60	50	22.7		✓
0.70	60	27.3	✓	
0.75	80	36.4	✓	
0.80	90	40.9	✓	
0.90	100	45.5	✓	
Parallel Winding Type of Spool			NO G3	NO G3

► **PRODUCT DESCRIPTIONS**

CORAL is developed from a special silicon formulation of Nylon copolymer material. RELIX CORAL is 8x more abrasion resistant compared to other common monofilament lines in the market whilst still managing to maintain the strength and other important characteristics. RELIX CORAL is very resistant to friction of line roller, rod guides, rough fishing environment such as rocks, snags, etc. as well as the teeth of targeted fish.

RELIX CORAL is ideal for fishing in waters with obstacles such as rocks, snags or other sharp objects. Approved by sea, carp and pike anglers.

SEA MARK is specially developed for sea fishing. Resistant to the effects of saltwater, RELIX SEA MARK can withstand friction of line roller, rod guides, rocky sea bed, ship wrecks etc. The special tin can package ensures that the line is never exposed to sunlight until actual usage (UV protection guaranteed).

RELIX SEA MARK can be used for all sorts of sea fishing, either from the beach (surfcasting) or from the boat. It is ideal for jigging near shipwrecks because of its high abrasion resistance.

IGFA CLASS LINE

IGFA RATED NYLON FISHING LINE
BORN FOR TOUGHER FISHING

Available Colors:



► **PRO TYPE** - IGFA Class Fishing Line

Dia	Lb	Kg	150m	300m	1000m
0.12	2	1	✓		
0.14	4	2	✓		
0.18	6	3	✓		
0.20	8	4	✓	✓	✓
0.25	12	6	✓	✓	✓
0.28	16	8	✓	✓	✓
0.33	20	10	✓	✓	✓
0.45	30	15	✓	✓	✓
0.55	50	24		✓	✓
0.75	80	37		✓	✓
0.95	130	60		✓	✓
Parallel Winding Type of Spool			YES C1	YES D2	NO H1 NO I1

► **PRODUCT DESCRIPTIONS**

PRO TYPE is an IGFA specifications compliant line. It means that the line will pass the IGFA test whenever you catch a record fish during a competition. RELIX PRO TYPE is also 6X more abrasion resistant than most of other IGFA class Nylon lines and is soft with very high knot strength. For more information about IGFA, please visit the IGFA-website at www.igfa.org.

RELIX PRO TYPE is mainly chosen by competition anglers and specimen hunters striving to catch a record breaking fish and have it recognized by IGFA.

Available Colors:



▲ CARP COMPETITION - Perfect For Competition

Dia	Lbs	Kgs	150m
0.20	6	2.7	✓
0.23	8	3.6	✓
0.26	10	4.5	✓
0.28	12	5.5	✓
0.30	15	6.8	✓
0.35	18	9.1	✓
Parallel Winding			YES
Type of Spool			C1

Available Colors:

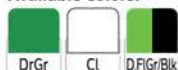

▲ BASS - Super Strong Bass Fishing Monofilament Line

Dia	Lbs	Kgs	200m
0.20	8	3.6	✓
0.22	10	4.5	✓
0.25	12	5.5	✓
0.28	15	6.8	✓
0.30	18	8.2	✓
0.38	20	9.1	✓
Parallel Winding			YES
Type of Spool			D1

▲ SEA CHALLENGER TOUR, VI, DX - Sea Fishing Line

Dia	Lbs	Kgs	300m
0.16	4	1.8	✓
0.18	5	2.3	✓
0.20	6	2.7	✓
0.25	10	4.5	✓
0.30	15	6.8	✓
0.35	20	9.1	✓
0.40	25	11.4	✓
0.45	30	13.6	✓
0.50	40	18.2	✓
0.60	50	22.7	✓
0.65	60	27.3	✓
0.70	70	31.8	✓
0.75	80	36.4	✓
Parallel Winding			YES
Type of Spool			D1 G3



▲ PRODUCT DESCRIPTIONS

RELIX CARP COMPETITION is a monofilament Nylon line especially developed for competitions where fishing is done at short distance such as carp float fishing. RELIX CARP COMPETITION is very strong and supple. The bright colors are designed to increase visibility to enable anglers anticipate the fish's every movement. It is also very useful when the competition is held under low light conditions. RELIX CARP COMPETITION is highly shock absorbent too, very important for fishing at close range. In short, RELIX CARP COMPETITION is the line that will give anglers maximum results when it counts the most. RELIX CARP COMPETITION is perfect for competition at close range especially carp float fishing. It is also ideal for fishing under low light conditions.

RELIX BASS is especially designed for bass anglers. RELIX BASS is soft and strong, allowing anglers to cast accurately and consistently. RELIX BASS has moderate elongation and abrasion resistance, which means excellent handling when fighting an aggressive fish like bass. This line is developed as the best line possible for bass fishing. It answers all demands for catching this extreme predatory fish.

RELIX SEA CHALLENGER series is developed especially for sea fishing. These lines are designed to resist the effects of saltwater. RELIX SEA CHALLENGER lines have good UV resistance, low stretch and great knot strength. RELIX SEA CHALLENGER series consists of **TOUR**, **VI** and **DX**. Tour and VI are very similar in characteristics, but DX is designed for high abrasion resistance to deal with tougher and rougher fishing conditions.

RELIX SEA CHALLENGER Series is suitable for all kinds of sea fishing applications. DX is recommended for Surf casting from the shore, casting from the rocks and vertical jigging over ship wrecks. TOUR and VI is perfect for vertical jigging, trolling, surf casting and deep-sea fishing.

Available Colors:



PERFECT FC - Perfect Fluoro Carbon Monofilament

Dia	Lbs	Kgs	30m	50m
0.10	2.5	1.1		✓
0.12	3	1.4		✓
0.14	4	1.8		✓
0.15	5	2.3		✓
0.18	6	2.7		✓
0.20	7	3.2		✓
0.22	8	3.6		✓
0.25	10	4.5		✓
0.28	12	5.5		✓
0.30	15	6.8		✓
0.35	18	8.2	✓	✓
0.38	20	9.1	✓	✓
0.40	25	11.4	✓	✓
Parallel Winding Type of Spool			NO E1	YES A1 YES C1

Dia	Lbs	Kgs	30m	50m
0.45	28	12.7	✓	✓
0.50	30	13.6	✓	✓
0.55	40	18.2	✓	✓
0.60	50	22.7	✓	✓
0.65	55	25.0	✓	
0.70	60	27.3	✓	
0.75	65	29.5	✓	
0.80	70	31.8	✓	
0.85	80	36.4	✓	
0.90	90	40.9	✓	
1.00	100	45.5	✓	
1.10	120	54.5	✓	
1.20	150	68.2	✓	
Parallel Winding Type of Spool			NO E1	YES A1 YES B1

Available Colors:



FLUROCARBON - 100% Fluoro Carbon with Best Value

Dia	Lbs	Kgs	30m	50m
0.10	2.5	1.1		✓
0.12	3	1.4		✓
0.14	4	1.8		✓
0.15	5	2.3		✓
0.18	6	2.7		✓
0.20	7	3.2		✓
0.22	8	3.6		✓
0.25	10	4.5		✓
0.28	12	5.5		✓
0.30	15	6.8	✓	✓
0.35	18	8.2	✓	✓
0.38	20	9.1	✓	✓
0.40	25	11.4	✓	✓
0.45	28	12.7	✓	✓
0.50	30	13.6	✓	✓
0.55	40	18.2	✓	✓
0.60	50	22.7	✓	✓
Parallel Winding Type of Spool			NO E1	YES B1

Available Colors:



MAX FLUROCARBON - Shock Leader with Maximum Elongation 30%

Dia	Lbs	Kgs	50m
0.14	4	1.8	✓
0.16	5	2.3	✓
0.18	6	2.7	✓
0.20	7	3.2	✓
0.22	8	3.6	✓
0.25	10	4.5	✓
0.28	12	5.5	✓
0.30	15	6.8	✓
0.35	18	8.2	✓
0.38	20	9.1	✓
0.40	25	11.4	✓
0.45	28	12.7	✓
0.50	30	13.6	✓
0.55	40	18.2	✓
0.60	50	22.7	✓
Parallel Winding Type of Spool			YES C1

PRODUCT DESCRIPTIONS

RELIX PERFECT FLUROCARBON – If you need a fast sinking line that is invisible underwater and of the highest possible quality, RELIX PERFECT FLUROCARBON is what you are looking for. This fluoro carbon line is of an absolute premium quality! It is 4x more abrasion resistant than common Nylon monofilament. It has very smooth surface, high strength and is softer than common fluoro carbon lines which also makes it easy to tie knots. RELIX PERFECT FLUROCARBON is ideal for making stiff carp rigs, flyline leader tippets or leaders for predatory fish that hunt in clear water. Basically, it is the best line in the world for any fish that you don't want to see your line.

RELIX FLUROCARBON is another Best value series of fluoro carbon from Relix. Invisible under water and affordable for more anglers. RELIX FLUROCARBON can be used on casting or spinning reels for freshwater fishing with good hook setting power, exceptional abrasion resistance and knot strength, and it's nearly invisible for fish.

RELIX MAX FLUROCARBON is described as a new generation of fluoro carbon. With higher Elongations, it has a shock leader that is designed to prevent the line breaking when the fish strikes and also improved abrasion resistance. As a 100% fluoro carbon, it is invisible in the water and has fast sinking properties. It is available in 4lb to 50lb breaking strength.

Available Colors:



FLURO CARBON HYBRID

127 - Mix of FC and Nylon, Faster Sinking

Dia	Lbs	Kgs	150m	300m	600m
0.25	8	3.6	✓	✓	✓
0.28	10	4.5	✓	✓	✓
0.30	12	5.5	✓	✓	✓
0.35	15	6.8	✓	✓	✓
0.40	20	9.1	✓	✓	✓
Parallel Winding Type of Spool			YES C1	YES D2	NO D2

RELIX 127 is a main line made of special compounding material consisting of fluoro carbon. It has been a dream of many anglers to have a fast sinking speed fishing line. Many line manufacturers tried to make fast sinking line but ended up creating a storm in a cup of water only. Today we are launching a REAL fast sinking line for anglers all over the world. Relix 127 is No Gimmick but simply just a heavier and thus faster sinking line. RELIX 127 is recommended as anglers' main line.



Available Color:

DEEP SEA JIGGING FLUOROCARBON - Leader Line for Deep Sea Jigging

Dia	Lbs	Kgs	50m
0.30	15	6.8	✓
0.35	18	8.2	✓
0.38	20	9.1	✓
0.40	25	11.4	✓
0.45	28	12.7	✓
0.50	30	13.6	✓
0.55	40	18.2	✓
0.60	50	22.7	✓
0.65	55	25.0	✓
0.70	60	27.3	✓
0.75	65	29.5	✓
0.80	70	31.8	✓
0.85	80	36.4	✓
0.90	90	40.9	✓
1.00	100	45.5	✓
Parallel Winding			NO
Type of Spool			E6

Available Color:

FLUORO CARBON LEADER - Superb Line for Leader

Dia	Lbs	Kgs	30m
0.30	12	5.5	✓
0.35	16	7.3	✓
0.40	20	9.1	✓
0.45	25	11.4	✓
0.50	30	13.6	✓
0.60	40	18.2	✓
0.70	60	27.3	✓
0.80	80	36.4	✓
0.90	100	45.5	✓
1.00	120	54.5	✓
1.20	150	68.2	✓
Parallel Winding			NO
Type of Spool			E1 E2

PRODUCT DESCRIPTIONS

RELIX DEEP SEA JIGGING FLUOROCARBON – Deep Sea Jigging Fluoro Carbon is an excellent leader line developed for tough fishing environment.

It's a strong, tough, high abrasion resistant and invisible Fluoro Carbon leader that will help angler to catch more fishes.

RELIX FLUORO CARBON LEADER LINE is used for diverse types of leaders. It is invisible underwater and extremely abrasion resistant, which makes it the best choice for making leaders for all kinds of predatory fish. Available in various sizes, up to 1.20 millimeter, RELIX FLUORO CARBON LEADER LINE is suitable for small and big fish, in fresh and saltwater.

RELIX FLUORO CARBON LEADER LINE is ideal for pike, musky and all sorts of game fish such as giant trevally, yellowfin tuna, black or even blue marlin. Also excellent for making catfish rigs!

Available Color:



▶ LEADER FOR POPPING - Stronger and Tougher

Dia	Lbs	Kgs	30m
0.80	80	36.4	✓
0.90	100	45.5	✓
1.00	120	54.5	✓
1.10	150	68.0	✓
1.20	170	77.2	✓
Parallel Winding			NO
Type of Spool			C1

Available Color:



▶ NYLON LEADER - High Elongation and Soft

Dia	Lbs	Kgs	100m
0.30	12	5.5	✓
0.33	15	6.9	✓
0.35	18	8.2	✓
0.40	20	9.1	✓
0.45	25	11.4	✓
0.50	30	13.6	✓
0.60	40	18.2	✓
0.65	50	22.7	✓
0.70	60	27.3	✓
0.75	70	31.8	✓
0.80	80	36.4	✓
0.90	100	45.5	✓
1.00	120	54.5	✓
1.20	150	68.2	✓
Parallel Winding			NO
Type of Spool			E1 E2



▶ WIND-ON LEADER MONOFILAMENT

Dia	Lbs	Kgs	Length (m)
0.45	20	9.1	4.50
0.50	30	13.6	4.50
0.65	50	22.7	4.50
0.80	80	35.6	4.50
1.00	100	45.5	4.50
1.20	150	68.2	8.50
1.40	200	90.9	8.50
1.60	300	136.4	8.50

▶ WIND-ON LEADER FLUOROCARBON

Dia	Lbs	Kgs	Length (m)
0.45	20	9.1	4.50
0.50	30	13.6	4.50
0.65	50	22.7	4.50
0.80	80	35.6	4.50
1.00	100	45.5	4.50
1.20	150	68.2	8.50

PRODUCT DESCRIPTION :

20 - 100 Lb

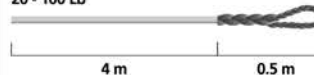

Monofilament/Fluorocarbon Braided Line

150 - 300 Lb



Monofilament/Fluorocarbon Braided Line

▶ PRODUCT DESCRIPTIONS

RELIX LEADER FOR POPPING Popping Leader is made with special formulated Nylon that has good abrasion resistance and good knot strength. Popping leader has nice shock absorption that could absorb the shock of first strike.

NYLON LEADER is a high elongation and very soft Nylon line with near-zero memory, which makes it very suitable for all kinds of leader applications. It is very easy to tie a knot with this line. It has very high knot strength and acts as a very effective shock absorber.

SPEED GAME is ideal for trolling in the sea. Since the leader doesn't have any knot, the strength is much improved.



JIGGING HOOK ASSIST - Single Hook, Double Hooks and Double Offset Hooks Hand Tied. Available in Hard Mono Core or Soft Wire Core.

With perfect quality of jigging hook assist, anglers will gain confidence in fish fighting.

'Opportunity seldom knocks twice'.

Jigging hook assist with hard mono core could reduce the chance of entangling hook to the leader during retrieving.

Jigging hook assist with soft wire core could prevent the cut of sharp object during the fish strike.

The strong hook yet small wire diameter will increase the strike rate.

▲ JIGGING HOOK ASSIST - SINGLE HOOK

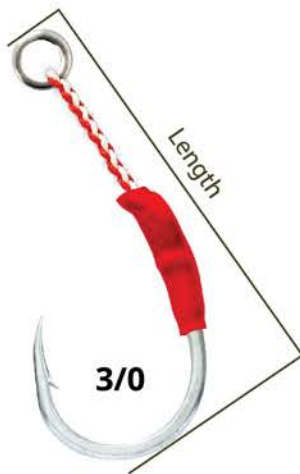

Hard Mono Core (Red/White)



Soft Wire Core (Blue/White)

Available Size	3/0	5/0	7/0	9/0	11/0
Length (cm)	5.9	6.7	7.9	8.3	10.3
Lbs Hard Mono Core	116	161	183	208	253
Lbs Soft Wire Core	116	161	183	208	253



▶ JIGGING HOOK ASSIST - DOUBLE HOOKS

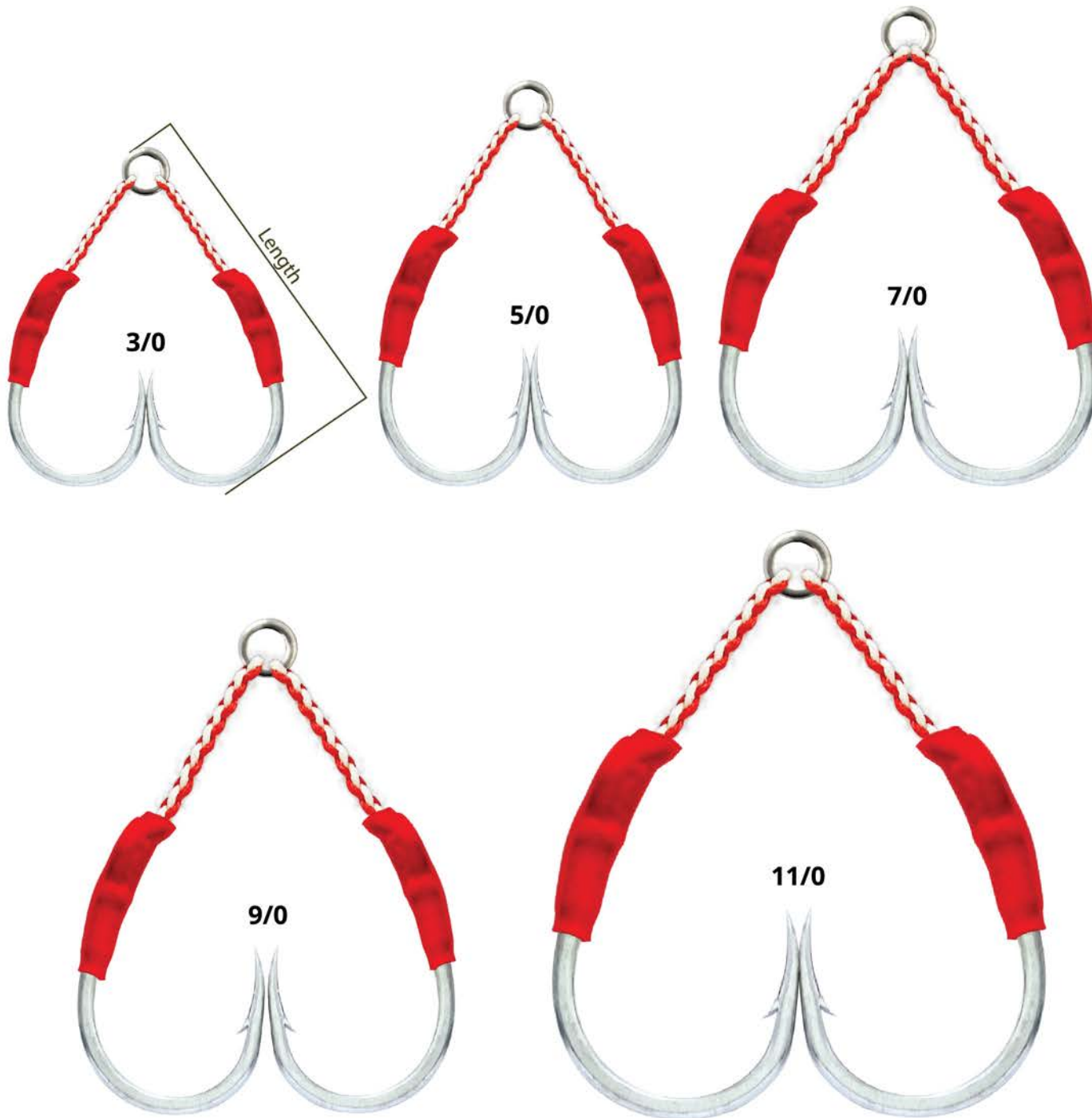

Hard Mono Core (Red/White)



Soft Wire Core (Blue/White)

Available Size	3/0	5/0	7/0	9/0	11/0
Length (cm)	5.9	6.7	7.9	8.3	10.3
Lbs Hard Mono Core	116	161	183	208	253
Lbs Soft Wire Core	116	161	183	208	253

▲ JIGGING HOOK ASSIST - DOUBLE OFFSET HOOKS

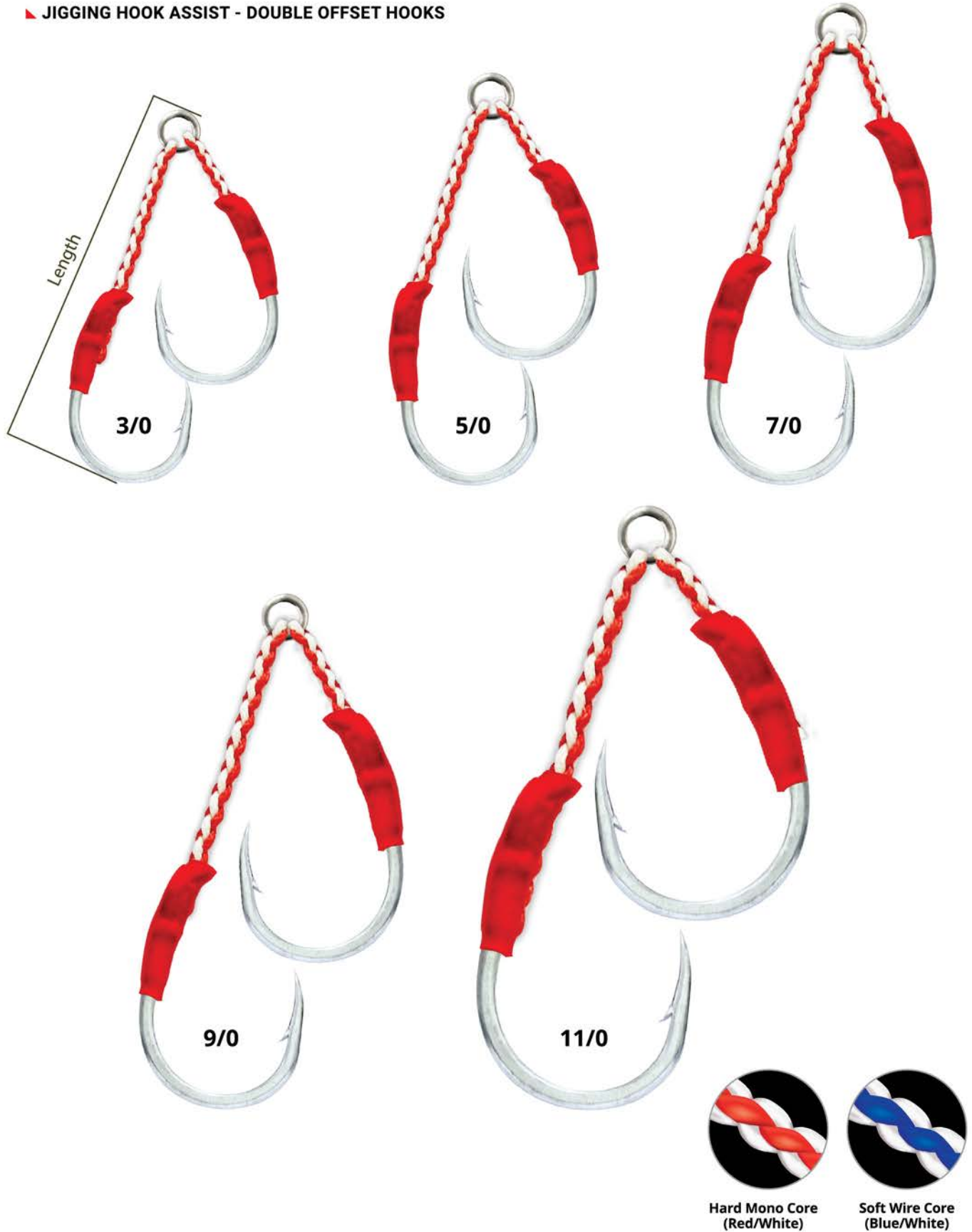

Available Size	3/0	5/0	7/0	9/0	11/0
Length (cm)	5.4 & 7.3	5.7 & 8	6.4 & 9	6.7 & 9.8	8.5 & 12.2
Lbs Hard Mono Core	116	161	183	208	253
Lbs Soft Wire Core	116	161	183	208	253



JIGGING HOOK ASSIST WITH TINSEL

Swims naturally like fish and increasing strike rate. Available in Single Hook, Double Hooks and Double Offset Hooks.

▶ **JIGGING HOOK ASSIST - SINGLE HOOK WITH TINSEL**



Available:



Hard Mono Core



Soft Wire Core

Available Hook Size	1/0	2/0	3/0
Length (cm)	4.3	4.6	5.5
Lbs	46	65	79

▶ **JIGGING HOOK ASSIST - DOUBLE HOOKS WITH TINSEL**

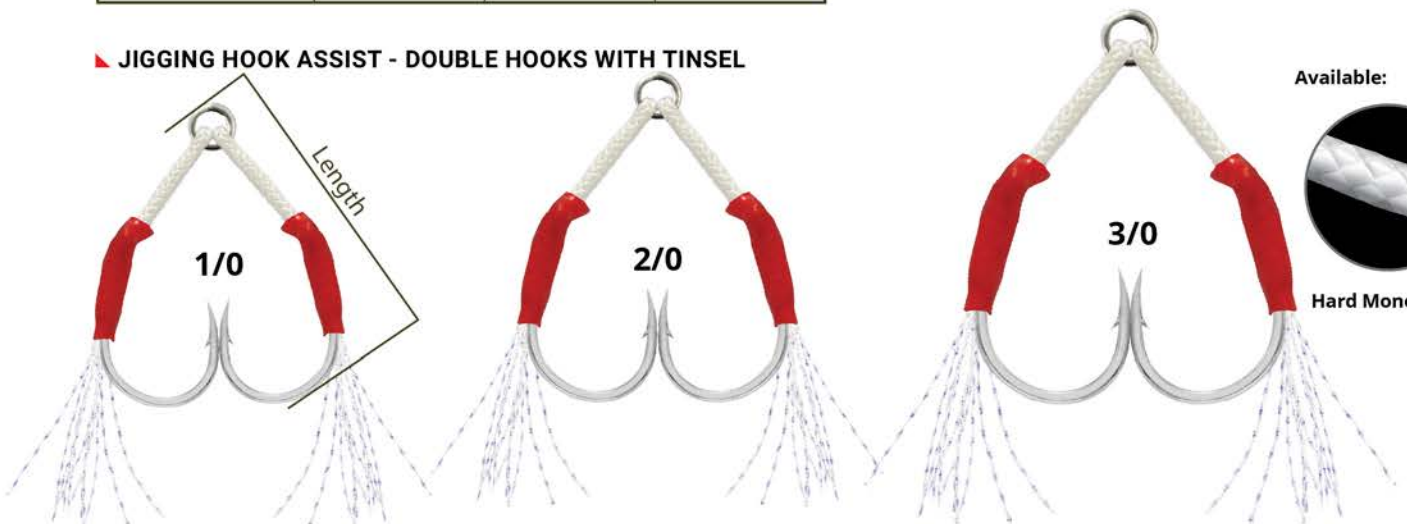

Available:



Hard Mono Core

Available Hook Size	1/0	2/0	3/0
Length (cm)	4.3	4.6	5.5
Lbs	46	65	79

▶ **JIGGING HOOK ASSIST - DOUBLE OFFSET HOOKS WITH TINSEL**



Available:



Hard Mono Core

Available Hook Size	1/0	2/0	3/0
Length (cm)	4.3 & 5.6	4.6 & 6	5 & 6.7
Lbs	46	65	79



JIGGING HOOK ASSIST WITH TINSEL

Relix Hook Assist tied with stiffer PE Assist (*), avoiding hooks from tangling. Relix Hook Assist has Ultra point hooks for easier hook set.

▶ **SLOW JIG HOOK ASSIST - DOUBLE HOOKS**

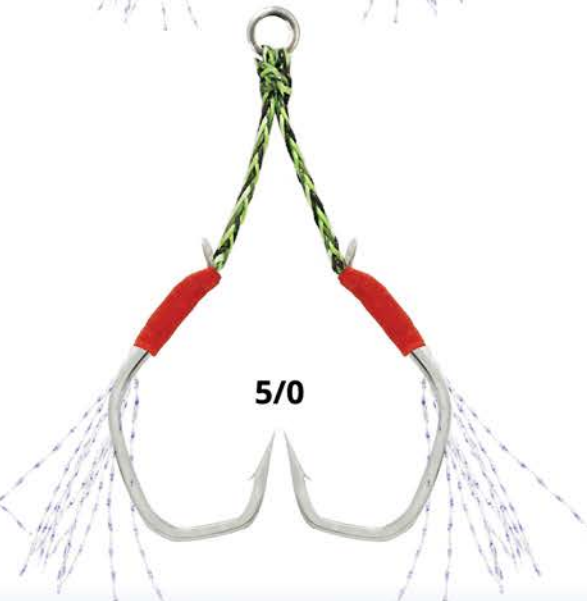
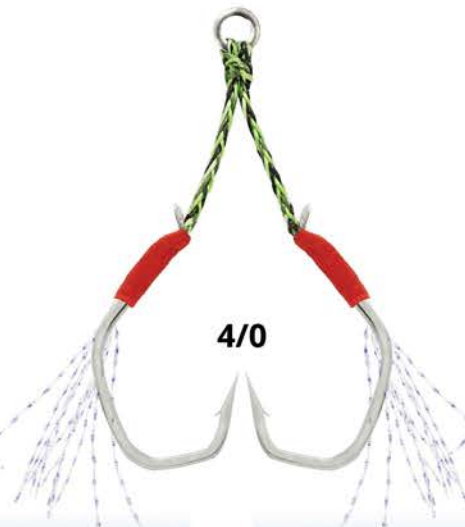
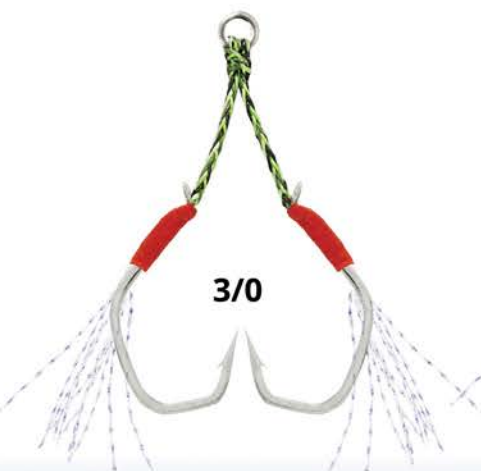
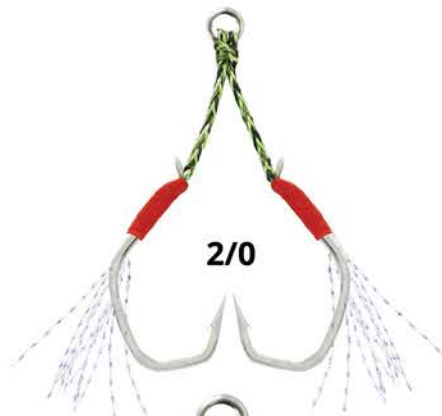
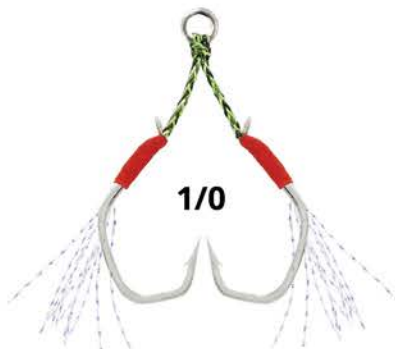
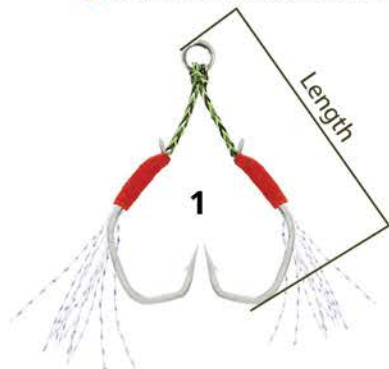

Available Size	1	1/0	2/0	3/0	4/0	5/0
Length (cm)	3.6	3.9	4.9	5.2	6	6.7
Lbs	34	44	60	65	70	108

Notes (*) these PE assists are 'Hand Braided' with recycled PE braid which makes color selection limited.



▶ SLOW JIG HOOK ASSIST - DOUBLE OFFSET HOOKS

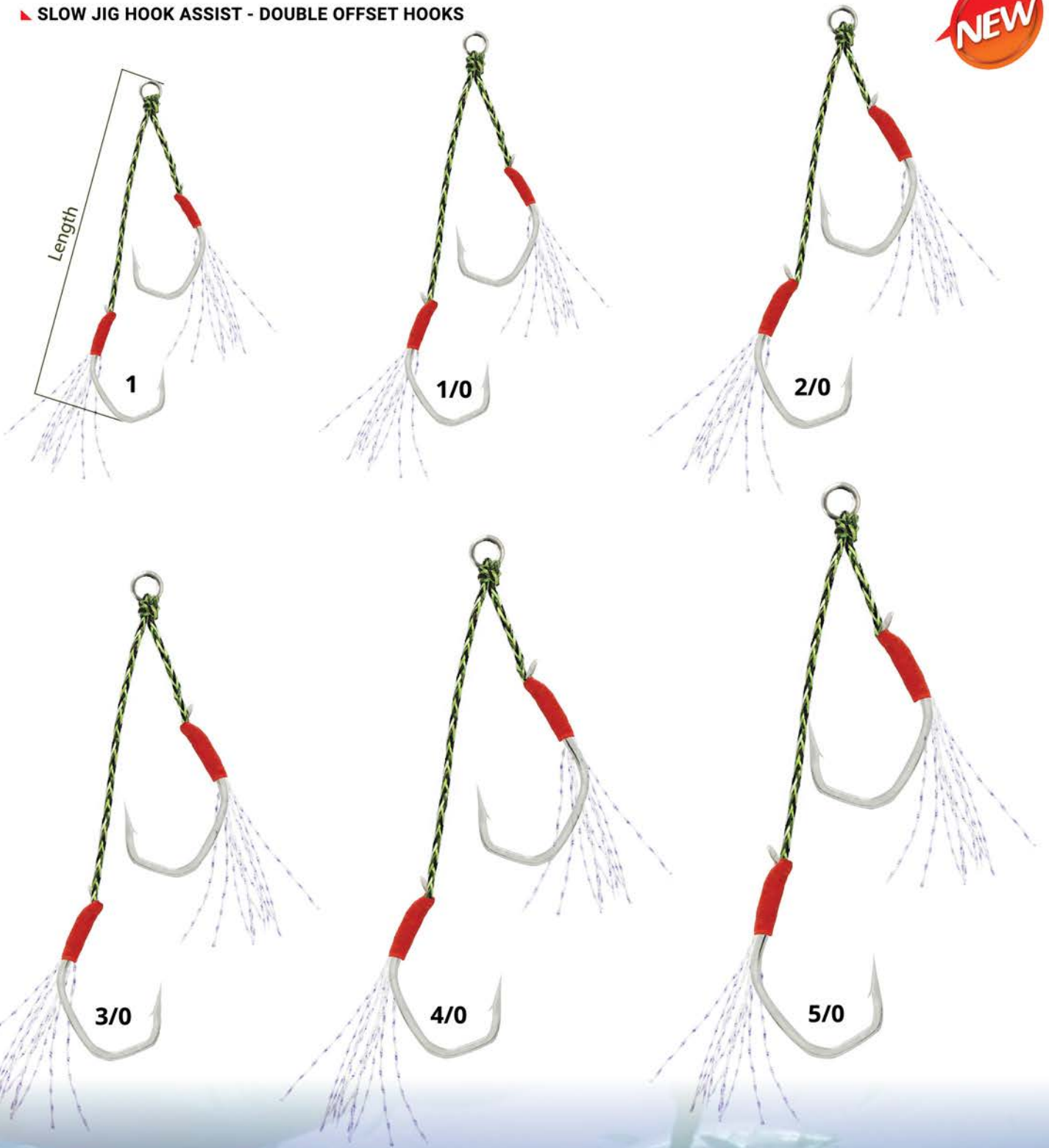

Available Size	1	1/0	2/0	3/0	4/0	5/0
Length (cm)	4.1 & 6.3	4.3 & 6.8	4.8 & 7.5	5.1 & 8.2	5.6 & 9.6	6.2 & 10.4
Lbs	34	44	60	65	70	108

Notes (*) these PE assists are 'Hand Braided' with recycled PE braid which makes color selection limited.

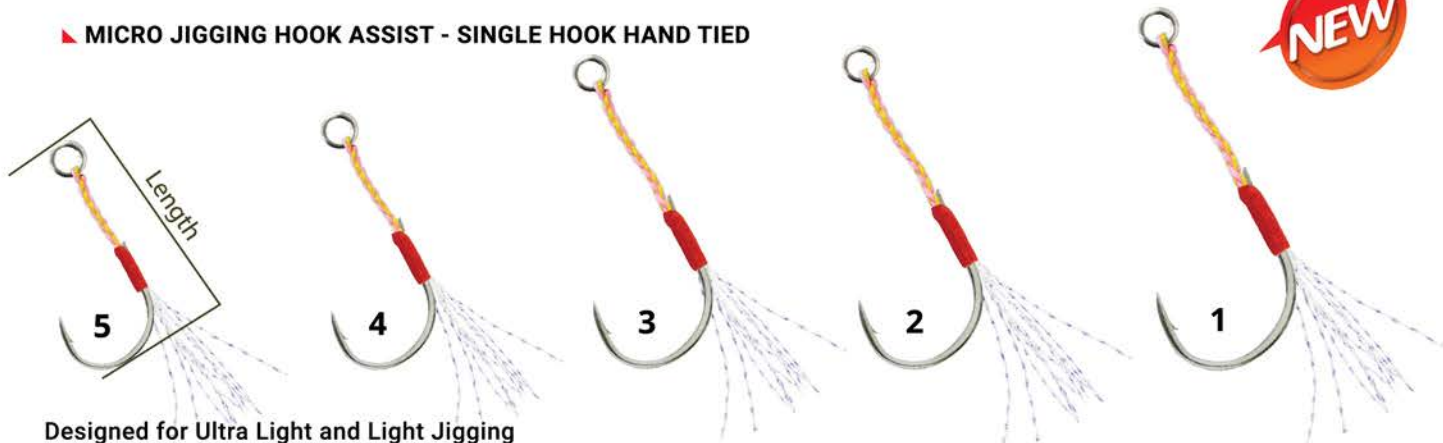
▶ MICRO JIGGING HOOK ASSIST - SINGLE HOOK HAND TIED

Designed for Ultra Light and Light Jigging

Available Size	5	4	3	2	1
Length (cm)	3.1	3.2	3.9	4	4.7
Lbs	19	24	31	36	44

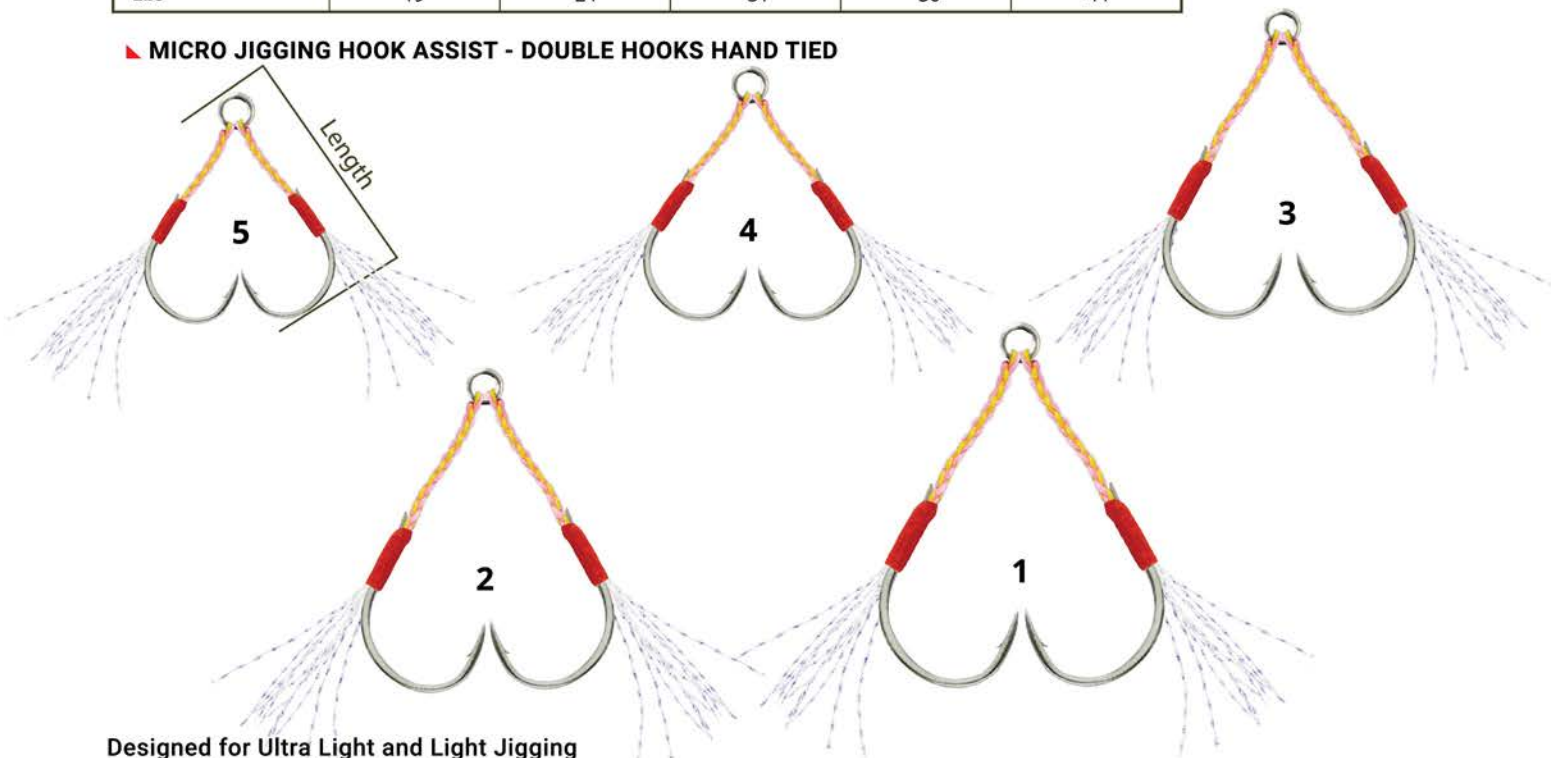
▶ MICRO JIGGING HOOK ASSIST - DOUBLE HOOKS HAND TIED

Designed for Ultra Light and Light Jigging

Available Size	5	4	3	2	1
Length (cm)	3.1	3.2	3.9	4	4.7
Lbs	19	24	31	36	44

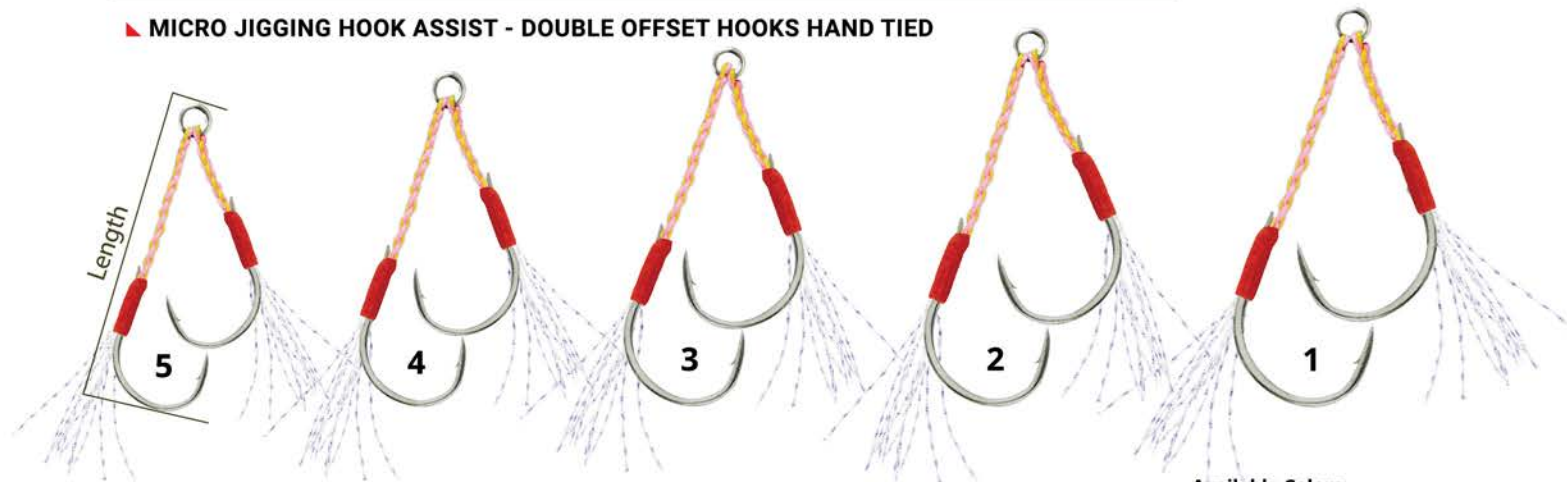
▶ MICRO JIGGING HOOK ASSIST - DOUBLE OFFSET HOOKS HAND TIED

Designed for Ultra Light and Light Jigging

Available Size	5	4	3	2	1
Length (cm)	3.1 & 4	3.2 & 4.2	3.4 & 4.5	3.7 & 4.7	3.8 & 5
Lbs	19	24	31	36	44

Available Colors:



▶ **ASSIST LINE 2x BRAIDED** **NEW**

Stiffer PE Assist (*), avoiding hooks from tangling.



Size 号	12	16	20	24	32	40	48	64
Lbs (Hard Mono Core)	125	140	170	180	200	250	270	350

▶ **ASSIST LINE WITH HARD MONO CORE**



HARD MONO CORE could reduce the chance of entangling hook to leader during retrieving.
Length is 3 meters.



Size 号	16	24	32	40
Lbs (Hard Mono Core)	165	220	260	300

▶ **ASSIST LINE WITH SOFT WIRE CORE**



SOFT WIRE CORE could prevent the cut of sharp object during the fish strike.
Length is 3 meters.



Size 号	16	24	32	32-X	40
Lbs (Soft Wire Core)	180	220	260	300	400

▶ **TYING FLOSS**



TYING FLOSS TYPE - A in 50 meters

Size 号	0.4	0.6	0.8
i-Dia (mm)	0.11	0.13	0.14
Color	Red		

TYING FLOSS TYPE - B in 50 meters

Size 号	0.5	0.7	1
i-Dia (mm)	0.13	0.15	0.17
Color	Black		

Notes (*) these PE assists are 'Hand Braided' with recycled PE braid which makes color selection limited.

▶ SOLID RING

Available Size mm (out dia.)	5.0	5.5	6.4	7.6	9.0	11.5
Lbs	125	130	130	150	220	226
Color	Black Nickle					

▶ SNAP

Available Size	00	0	1	2
Color	Black Nickle			

▶ CRANE SWIVEL

Available Size	2	1/0	3/0	5/0
Kgs	51	75	122	160
Color	Black Nickle			

▶ ROLLING SWIVEL

Available Size	4	6	8
Kgs	38	27	18
Color	Black Nickle		

▶ SHRINK TUBE



3X
SHRINK
RATIO

Available Size mm (out dia.)	4.5 mm	6.5 mm
Length	8 cm x 6	
Colors	Red, Black, Transparent	

▶ SPLICING NEEDLE

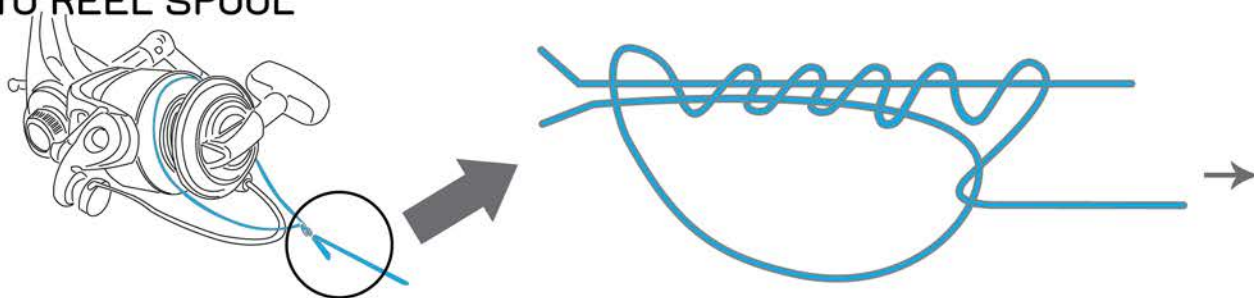

RECOMMENDED KNOTS - Guides you for better fishing

▶ **LINE TO REEL SPOOL**

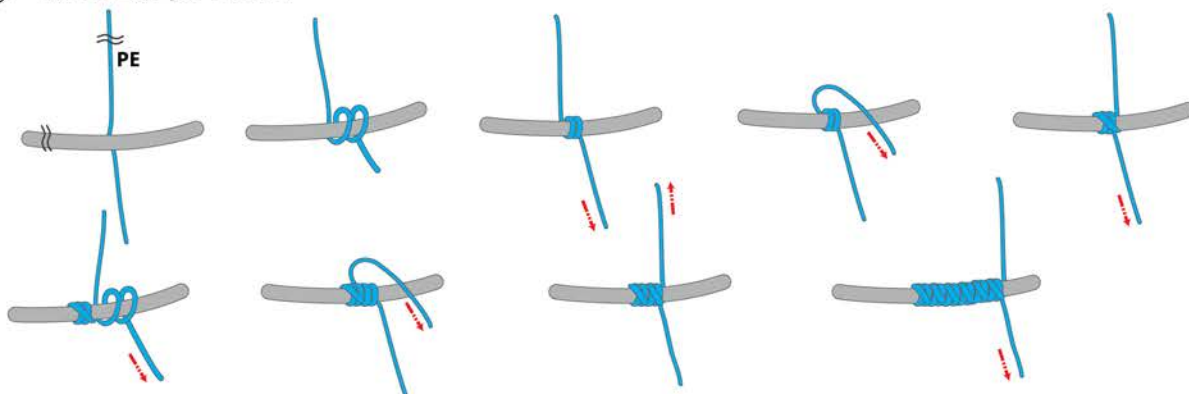

▶ **RELIX KNOT** (see page 40 for details)

① **KNOT 2x1 , 6 TIMES**



② **KNOT TO LEADER THEN KNOT TO (PE+LEADER), REPEAT 8 OR 20 OR 30 TIMES**

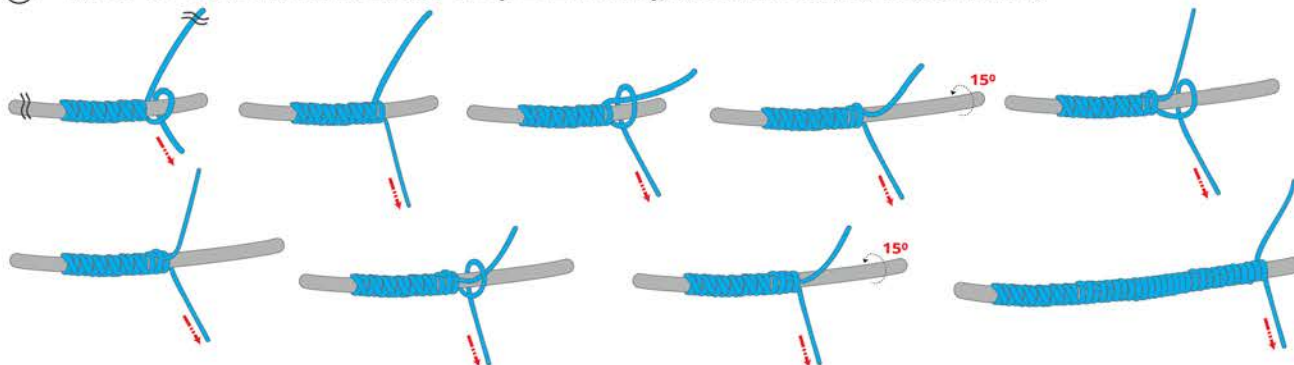

③ **ONE LOCKING KNOT, THEN REPEAT 6 TIMES OF REVERSE LOCKING KNOT**

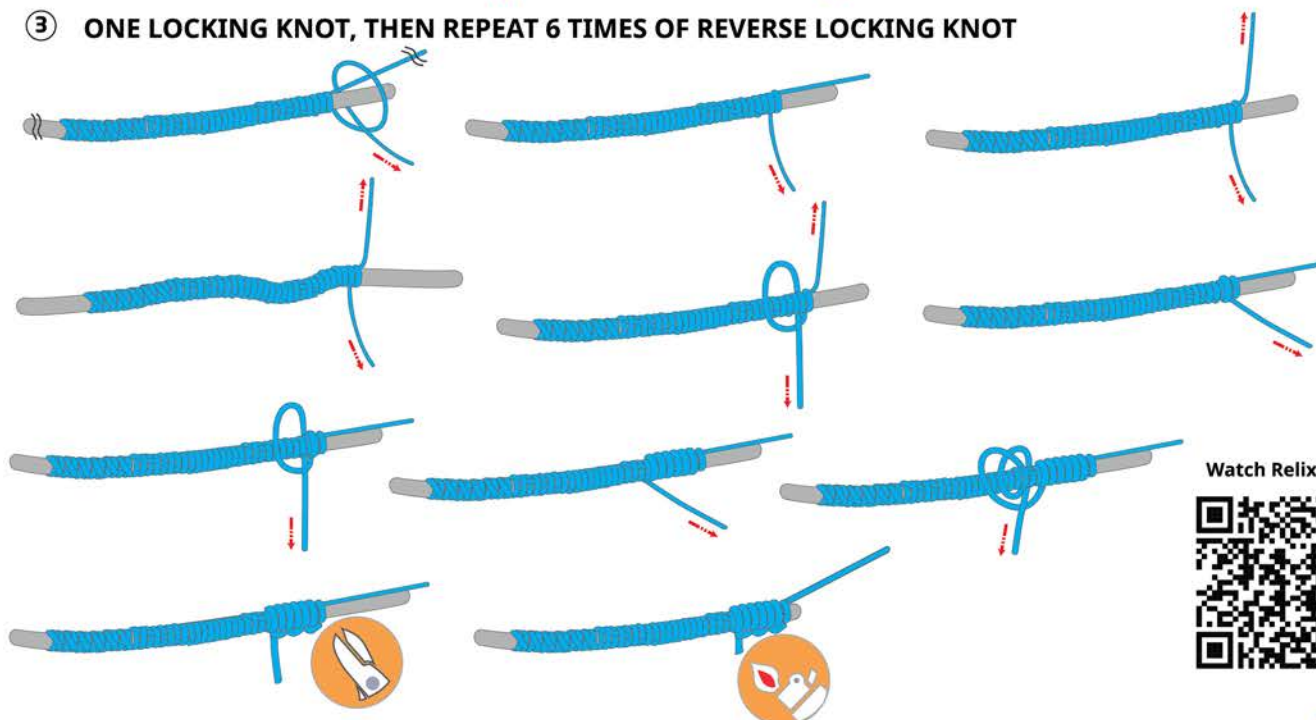

Watch Relix Knot

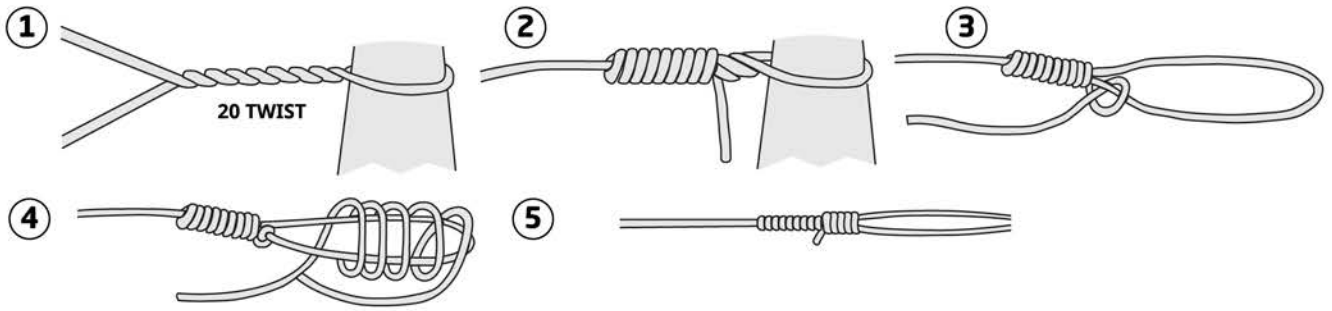
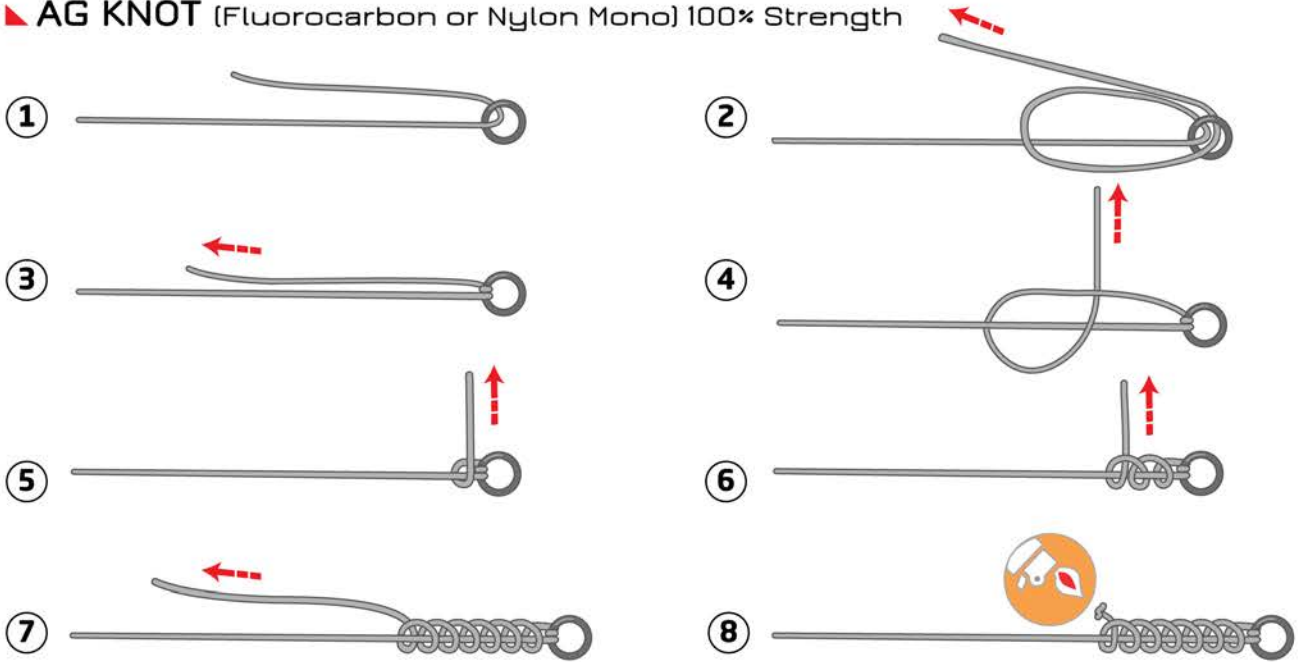
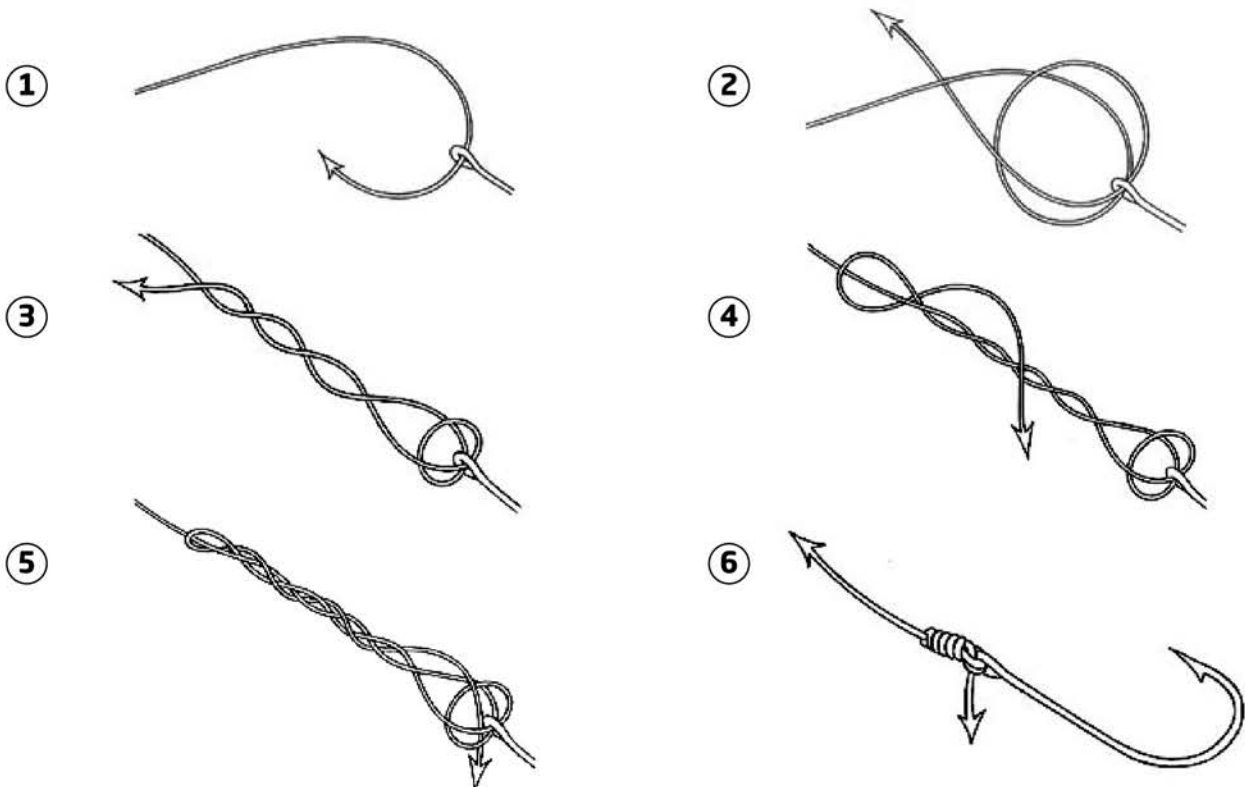

▶ BIMINI TWIST (Connect to Leader or Swivel)

▶ AG KNOT (Fluorocarbon or Nylon Mono) 100% Strength

▶ REVERSE TWIST KNOT (Fluorocarbon or Nylon Mono) 100% Strength

A. MESSAGES ON OUR LINE PACKAGING

1. **Monofilament Diameter \varnothing**
This number expresses average diameter of monofilament
2. **PE Braided line *i*-Dia (indicative Diameter)**
This number expresses equivalent Dia of monofilament to the PE line.
Eg. PE with *i*-Dia of 0.30mm will fit 100 m into a reel's spool with line capacity of Nylon (mm-m) 0.30-100
3. **Gou (号) – PE No.**
This number expresses a linear measurement of PE line size according to standard from JAFTMA.
Eg. No.1 = 200 denier; No.2 = 400 denier.
4. **Strength (Lbs or Kgs)**
Average amount of load required to break the line in a standard tensile testing machine.
5. **Line Length 100 yds equals to 91m, Line Weight 1 pound equals to 0.454kg**
This number indicates the amount of line in a packaging unit such as spool or coil. It could be expressed as length (m or yards) or weight (kg or pound(#)).
6. **Parallel Winding.**
Indicates advanced winding system. With this system, the line is arranged evenly parallel on the spool. Each layer stacks neatly on top of the next layer with controlled pressure to avoid damage to the line itself.
7. **Yarn Content**
Yarn content is the number of yarns used to produce a specific braided line.

B. ABOUT LINE SIZE AND STRENGTH

When you have decided your target fish and fishing method, then you must pick the suitable rod, decide your line (type and strength) and then choose the most suitable reel. These are the steps on how to pick your fishing gear.

The line strength should match your line rating on rod.

The line size serves as a guideline for you to decide the reel size.

1. Line size

The size of monofilament lines are commonly measured in diameter.

The size of PE braided lines are commonly measured in Gou (号) in Asia and for internationally, sizes are measured in dia (mm).

- Nylon and Fluoro carbon monofilament Line - dia (mm) and Gou(号)
Dia (diameter) is measurement of the round cross section of the monofilament.
Gou (号) is popular as line sizing in Japan, No.1 = 220 denier, No.2 = 440 denier.
- PE braided line – Gou (号) and *i*-Dia (mm)
Gou (号) is popular as PE line sizing in Asia, No. 1 = 200 denier, No.2 = 400 denier.
i-Dia (indicative Diameter) compares the Dia of monofilament to the PE line sizing.
Eg. PE with *i*-Dia of 0.30mm will fit 100 m into a reel's spool with a line capacity of Nylon (mm-m) 0.30-100

Notes

Denier is a unit of line size by weight(gram) of 9,000m.

Effectively used on multifilament line sizing such as PE Braided.

200 d means size of line is 200 gr/ 9,000 m.

Monofilament Line

Gou (号)	Dia (mm)
0.1	0.053
0.15	0.064
0.2	0.074
0.25	0.083
0.3	0.090
0.35	0.097
0.4	0.104
0.5	0.117
0.6	0.128
0.8	0.148
1	0.165
1.2	0.185
1.5	0.205
1.75	0.220
2	0.235
2.25	0.248
2.5	0.260
3	0.285
3.5	0.310
4	0.330
5	0.370
6	0.405
8	0.470
10	0.520
12	0.570
14	0.620

PE Braid Line

Gou (号)	Denier	PE i-Dia (mm)
0.1	20	
0.15	30	
0.2	40	
0.25	50	0.08
0.3	60	0.09
0.35	70	0.10
0.4	80	0.11
0.5	100	0.13
0.6	120	0.14
0.8	160	0.16
1	200	0.17
1.2	240	0.20
1.5	300	0.22
1.7	340	0.23
2	400	0.25
2.5	500	0.28
3	600	0.30
4	800	0.35
5	1000	0.39
6	1200	0.43
8	1600	0.49
10	2000	0.54
12	2400	0.59
15	3000	0.65

2. Line Strength

- Line strength (Lbs/ kgs)
is a strength test of a monofilament or braided line in tensile test machine.
- Knot strength(Lbs/ kgs)
is a strength test of a monofilament or braided line with an extreme knot in tensile test machine.

When applied in fishing, normally a Monofilament line will have a drop of 20% to 30% from its Line strength. PE braided line will have a drop of 20% to 40% strength if connected to leader with a proper knot and will drop by 50% or more (without leader).

C. APPLICATION TEST

The concept of Application Test is based on the idea that we produce fishing lines for anglers, not for laboratory engineers. Application test is an effort to understand as many relevant factors as possible that affect the line or its function when anglers go fishing, and to include them in our product quality assurance system. These factors are translated into technical parameters which are measured and tested during production, and provided to anglers as the line's technical information.

We also apply application tests to our packaging such as the spools or bobbins and the boxes. In these tests, we studied the conditions under which our lines are stored and displayed in the stores; how they are wound into fishing devices; and how it would be used.

We've started to implement the application test project since 2005. The results we obtained from these tests are used as basis for:

1. Continual improvement of our existing products and development of new product innovations.
2. Customer support in the form of technical information and tips.

D. RELIX PRODUCT TESTING STANDARDS

1. Strength / Knot Strength to Elongation

The strength of a line is tested based on ISO 2062:1993 using a CRT (Constant Rate of Travel) testing machine. A sample with a grip to grip length of 500 mm, is pulled at constant speed of 500 mm/minute until it breaks. The load recorded at the moment it breaks is the breaking force.

Knot strength is tested exactly the same way as breaking strength, but the sample is pulled with a simple knot tied beforehand at the middle of its length for monofilament and with Relix recommended knot for Braided line.

2. Flexibility Test

In the flexibility test, the line sample is gripped at one end, and the force required to push the sample at a certain position from the fixed end until it makes 30o angle with its original position is a measure of the line's flexibility.

3. Twist Resistance

Twist resistance is the ability of a line to resist the shear stress caused by twisting. In reality twist could happen during fishing with spinning reel. A twist test is conducted by attaching line to a spinning reel at one end and a swivel with certain load at the other end. Then we turn the spinning reel to create twist in the line. The test is conducted until the line breaks. Number of twist is recorded as twist resistance.

4. Abrasion Resistance Test

Abrasion resistance of a line is tested by applying the line sample to a rotating sand paper until it breaks. The number of rotations of the sand paper shaft required to break the line is a measure of abrasion resistance of the line.

5. Color Measurement

In this test an L.a.b. colorimetric device is used. The test results can be explained as follows:

- a>0 indicates redness on a scale from 0 to 100
- a<0 indicates greenness on a scale from -100 to 0
- b>0 indicates yellowness on a scale from 0 to 100
- b<0 indicates blueness on scale from -100 to 0
- L indicates lightness on scale from 0 (black) to 100 (white).

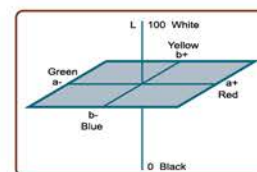
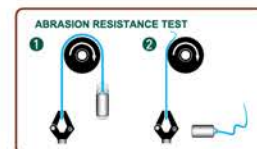
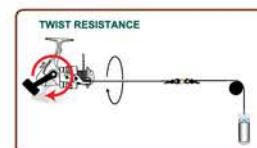
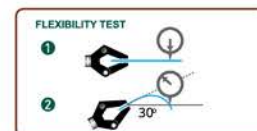
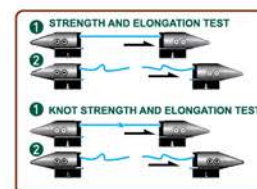

E. RELIX LINE AND IGFA

IGFA is an acronym for International Game Fish Association whose purpose, among others, is to keep the sport of game fishing ethical by making rules and standards, and to keep an attested and up-to-date chart of world record catches.

One of the rules has to do with the breaking strength of fishing lines used to make the record catch. Lines are divided into several classes according to their breaking strength. For a catch to qualify a certain line class record, the line used must be proven to be in the class range or lower. If it is higher than the class, then it will be considered for the next class record. But this is usually a disadvantage because the next higher class line category would have a record that is also higher. In simple way, IGFA class line could be explained as a line whose actual strength must not exceed its stated or printed value on the packaging.

Following are Line Classes set by IGFA.

Metric	US Customary
1kg	2lb
2kg	4lb
3kg	6lb
4kg	8lb
6kg	12lb
8kg	16lb
10kg	20lb
15kg	30lb
24kg	50lb
37kg	80lb
60kg	130lb

F. RELIX KNOT

Relix knot is our phenomenal knot. With great effort you could reach to almost 100% of Braided strength. However you could also turn Relix knot to an easy and simple knot.

While most of other knot has only 2 zones, Relix knot has 3 zones.

1st zone is holding zone.

2nd zone is shock absorbing zone.

3rd zone is locking zone.

- The 1st zone starts with 2 winds from the end part of PE (Free part) on the leader then following by 1 counter winding from the main part of PE.
Do the winding firm and moderately tight for repeat of 6 times.
- The 2nd zone starts with winding from the Free part of PE on leader only, following by winding from Free part of PE on leader+main part of PE, then you tighten the winding by pulling till the leader twist.
Do the winding firm and moderately tight for the repetition of 10 times (simple), 20 times(standard) till 30 times (optimal performance).
By the end of winding, you should see the main part of PE make a circling on the leader.
- The 3rd zone, the locking zone start with 1 winding from Fee part of PE, then do the half hitch.
The 1st half hitch make a temporary holding. We should inspect, readjust the knot tension and if everything is fine, then we could do another 5 times of half hitch with reverse direction and sit on the 2nd zones knot.
The last knot is half hitch with double locking to ensure the knot is securely lock.
- You can then pull the leader and PE to tighten, cut the excess of free part PE and burn the end PE(optional). The knot is now ready to use.











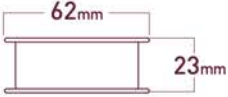

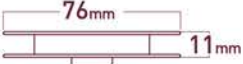

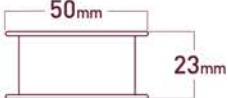

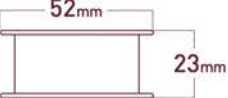
COMPARISON CHARACTERISTIC OF NYLON MONOFILAMENT, FLOURO CARBON MONOFILAMENT AND BRAIDED MULTIFILAMENT.

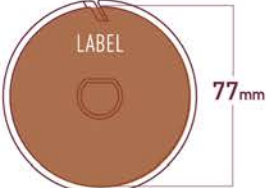
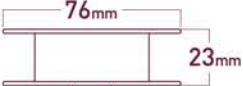
Description	Nylon Monofilament	FC Monofilament	Braided Multifilament	Water
Raw material	Nylon	PVDF	PE	
Appearance				
• Cross section shape and type	Round and firm	Round and firm	Not round not firm	
• Transparancy	Transparent or Opaque	Transparent	Opaque	
Tenacity				
• Recommended knot to linear strength	80%-100%	70%-95%	70%-95%	
• Strength in water	85%-95%	100%	100%	
Other Spec :				
• Elongation at break	20%-30%	20%-30%	3%-5%	
• Gravity index	1.14	1.78	0.97	1.00
• Reflection index	1.58	1.42	None	1.34
• Water absorption	5%-15%	0.1%	0.1%	
• Hook setting sensitivity	☐	▲	◎	
• Flexibility	▲	☐	◎	
• Abrasion resistance	▲	◎	▲	
• UV resistance	▲	◎	◎	
• Memory	☐	☐	◎	

◎ BEST

▲ GOOD

☐ MODERATE

DIMENSION SPOOL	NAME	NOTE
		A1 DW 50
		A2 ST 50
		A3 DW 20
		A4 DW 25
		B1 PL 100
		B2 ST 100
		B3 SL 100
		B4 FL 25
		B5 FL 50

DIMENSION SPOOL	NAME	NOTE
	B6	YG
	C1	PL 150
	C2	UNT
	D1	PL 305
	D2	PL 300
	D3	WTC
	D4	WTC2

DIMENSION SPOOL	NAME	NOTE
	E1	LDR
	E2	LDR2
	E3	LS
	E4	LM
	E5	LL
	E6	LDS

DIMENSION SPOOL		NAME	NOTE
		F1	MGC 1/8
		F2	FG 1/8
		G1	MGC 1/4
		G2	FG 1/4
		G3	DT 1/4
		H1	MGC 1/2
		H2	SP40-S
		H3	SP40-M
		H34	SP40-L
		I1	BBS

DOUBLE SIDED TACKLE BOX

NEW

4000

4500

With dividers adjustable up to 20 compartments

With dividers adjustable up to 18 compartments

TB 4000 DIMENSION

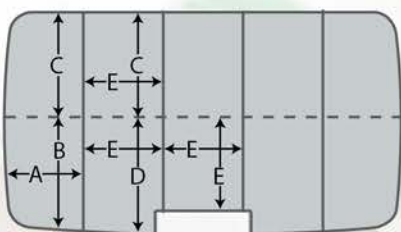

Outside dimensions

185 mm x 100 mm x 55 mm

A = 30 mm B = 43 mm C = 40 mm

D = 44 mm E = 31 mm

TB 4500 DIMENSION

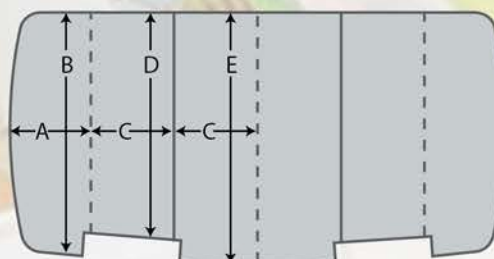

Outside dimensions

230 mm x 115 mm x 60 mm

A = 32 mm B = 98 mm C = 33 mm

D = 90 mm E = 102 mm

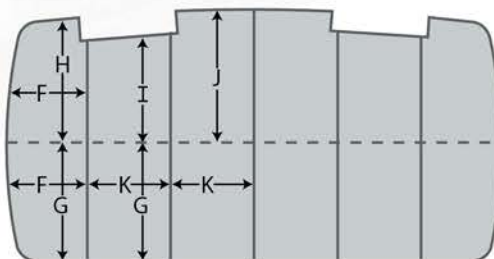

F = 31 mm G = 47 mm H = 48 mm I = 41 mm

J = 52 mm K = 33 mm

A smart way to organise your tackles

ABOUT SYSTEM TACKLE BOXES

The tackle box 6250 has a full size lift-out tray five worm-proof compartments with handle. Made of the finest quality, 100% wormproof plastic material. The overlapping lid keeps rain out. Simple and functional, it's a great starter box for anyone. Water proof and impact resistant. With outside dimension: 210 mm x 385 mm x 182 mm



TB 6250

**100%
WORMPROOF**



TB 6300

Frosty White / Brown



TB 6200

MAIN COLORS:



Metallic Blue / Grey



Metallic Red / Grey



Metallic Green / Grey

6 SPECIAL COLORS:



Apple Green / Grey



Banana Yellow / Grey



Chilli Red / Grey



Fluo Orange / Dark Grey



Sky Blue / Dark Grey



Purple / Dark Grey



TB 6100

ITEM	OUTSIDE DIMENSION	COMPARTMENTS
TB RELIX 6100 (1 TRAY BOX)	210 mm x 380 mm x 160 mm	10
TB RELIX 6200 (2 TRAY BOX)	210 mm x 385 mm x 182 mm	23
TB RELIX 6250 (2 TRAY BOX)	210 mm x 385 mm x 182 mm	-
TB RELIX 6300 (3 TRAY BOX)	230 mm x 440 mm x 205 mm	37

Fit more tackles
in less space

LAYER TACKLE BOXES
DOUBLE LAYER TACKLE BOXES

TACKLE BOXES



**100%
WORMPROOF**

TB 3007



Yellow / Dark Grey

Red / Dark Grey

Blue / Dark Grey

With dividers adjustable up to
50 compartments

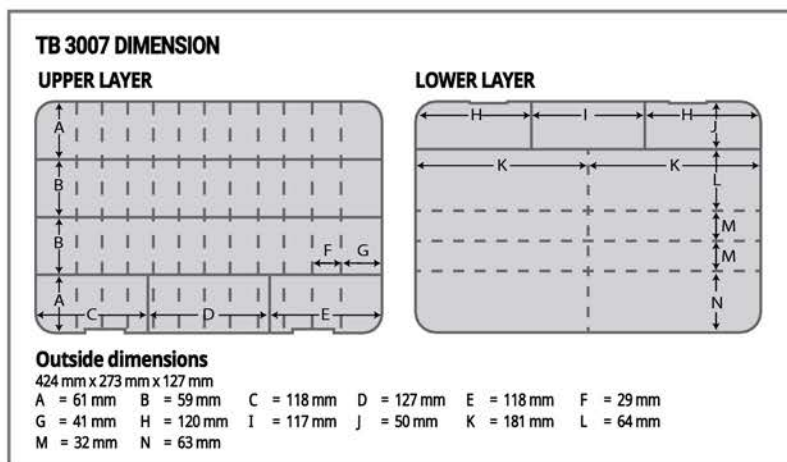

AVAILABLE COLORS:



CAMOU GREEN / DARK GREY



WHITE / DARK GREY



RED / DARK GREY



YELLOW / DARK GREY



BLACK / DARK GREY

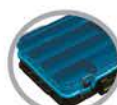

BLUE / DARK GREY

TB 4700

**100%
WORMPROOF**



With dividers adjustable up to
45 compartments



TB 4700 DIMENSION

UPPER LAYER

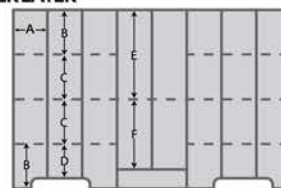

LOWER LAYER

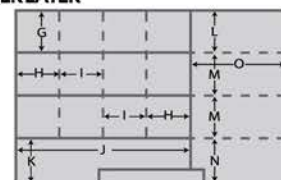

Outside dimensions

355 mm x 229 mm x 71 mm
A = 39 mm B = 51 mm C = 51 mm D = 39 mm
E = 104 mm F = 82 mm G = 49 mm H = 50 mm
I = 50 mm J = 206 mm K = 53 mm L = 49 mm
M = 49 mm N = 53 mm O = 113 mm

ABOUT SYSTEM TACKLE BOXES

Relix has created a system of tackle boxes called: Relix System Tackle Boxes. This system consists of Relix Main Box (CMB), Small Box (CSB2, CSB3, CSB4) and the Compact Boxes (CCB). Small Boxes are designed to fit nicely in the Relix Main Box and Compact Box. All lids are in transparent gunsmoke color with lower parts available in 4 colors (Yellow / Grey, Dark Green / Grey, Red / Grey, Blue / Grey). Equipped with very strong lock, these boxes are very reliable, close tightly and easy to open.

CMB and CCB are very strong and handy due to the compact design. They come with fixed compartments which can easily fit two CSB each, and a front part which can be adjusted with Smart Divider system as needed.

TB CMB
Yellow / Grey



TB CMB DIMENSION

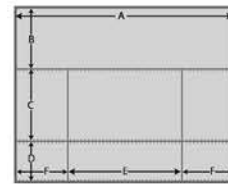

Outside dimensions

310 mm x 370 mm x 65 mm
A = 350 mm B = 97 mm C = 112 mm D = 64 mm
E = 180 mm F = 83 mm

TB CCB



TB CCB DIMENSION

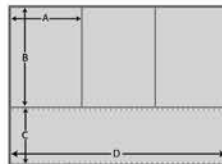

Outside dimensions

260 mm x 220 mm x 60 mm
A = 80 mm B = 111 mm C = 64 mm D = 244 mm

SMART DIVIDER SYSTEM



TB CSB3

TB CSB2

TB CSB4

STANDARD COLORS FOR ALL ITEMS:



Dark Green / Grey



Yellow / Grey



Red / Grey



Blue / Grey

TB CSB Series



TB CSB2 DIMENSION



Outside dimensions

107 mm x 77 mm x 25 mm
A = 99 mm B = 28 mm

TB CSB3 DIMENSION



Outside dimensions

107 mm x 77 mm x 25 mm
A = 58 mm B = 32 mm

TB CSB4 DIMENSION



Outside dimensions

107 mm x 77 mm x 25 mm
A = 49 mm B = 28 mm

**100%
WORMPROOF**

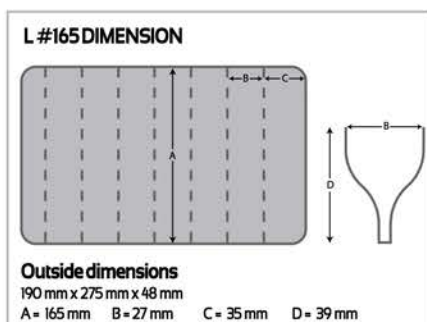
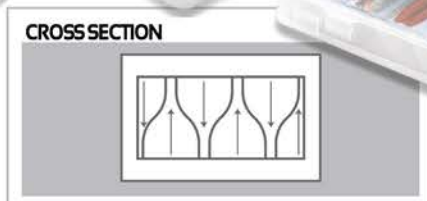
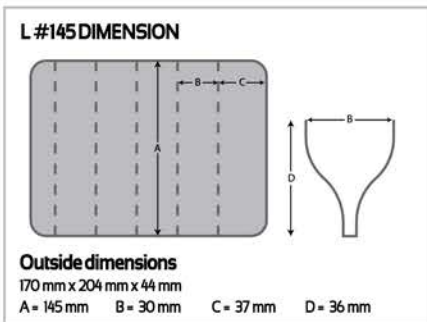
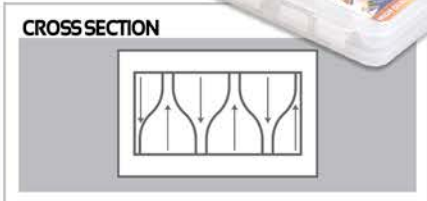
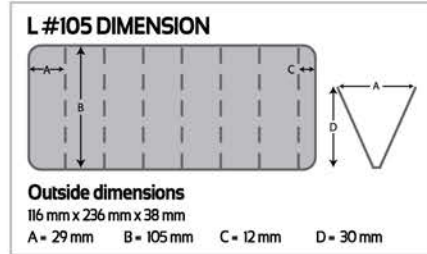
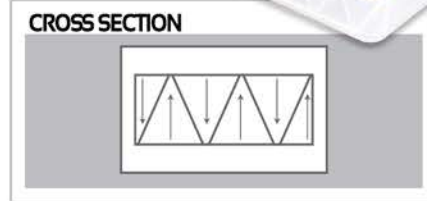
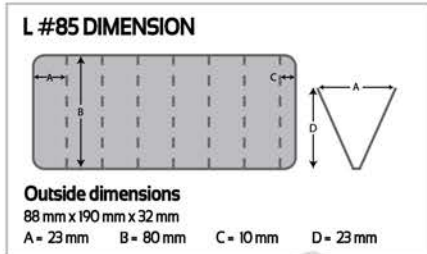
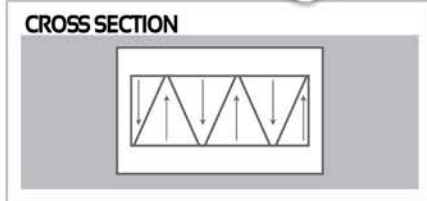
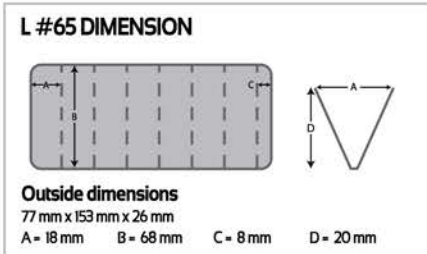
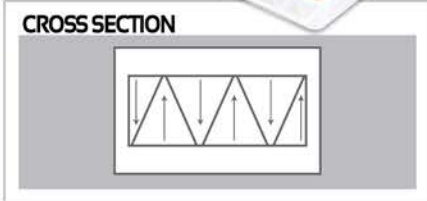

ABOUT SMART LURE BOXES
Ever noticed how time and space consuming it is to store jigs or hard lures in your tackle box? It's always too big or not big enough. Well, Relix's double sided Smart Lure Boxes are specifically designed to solve this problem. Their triangular compartments allow lures and jigs to be stored efficiently on both sides of the box. This means you can store much more lures in our smart lure

boxes than in regular tackle boxes. Relix Smart Lure Boxes come in five sizes: L#65, L#85, L#105, L#145 and L#165, all fitted with drain holes to keep water from accumulating inside the box causing the lure hooks to rust. Ideal for hard lures, but also recommended for leadfish and squid jigs.

LURE BOX SMALL

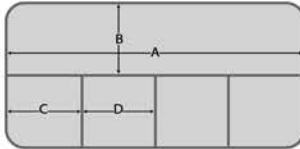
LURE BOX SMALL DIMENSION

Outside dimensions

 178 mm x 98 mm x 30 mm
 A = 171 mm B = 41 mm C = 43 mm D = 41 mm

**100%
WORMPROOF**

LURE BOX MEDIUM

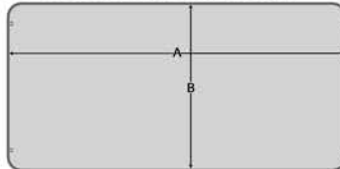
 With dividers adjustable
 up to 12 compartments

LURE BOX MEDIUM DIMENSION

Outside dimensions

 200 mm x 109 mm x 51 mm
 A = 194 mm B = 96 mm

TRAY FOR LURE BOX MEDIUM

Dimensions

 193 mm x 95 mm x 20 mm
 A = 189 mm B = 59 mm C = 31 mm F = 37 mm G = 15 mm

ABOUT COMPACT LURE BOXES

When fishing predatory fish, it is important to have a tackle box that can organize the lures properly and at the same time hold the tools associated with the style of fishing. ReliX Compact Lure Boxes are designed for this purpose. Comes in clear color, it is available in three sizes: small, medium and large. The small Lure box consists of 4 small compartments for lures and 1 long compartment at the back for bigger items. The medium and large Lure Boxes consists of a removable tray that can be divided into compartments using the included smart dividers. The bottom of the box can be used to store large items such as tools or bigger lures.

LURE BOX LARGE

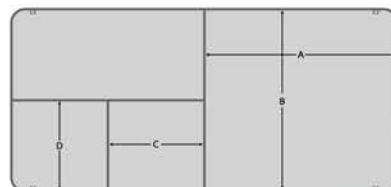
LURE BOX LARGE DIMENSION

Outside dimensions

 259 mm x 133 mm x 59 mm
 A = 125 mm B = 119 mm C = 62 mm D = 59 mm

TRAY FOR LURE BOX LARGE

Dimensions

 249 mm x 118 mm x 29 mm
 A = 246 mm B = 41 mm C = 74 mm H = 171 mm I = 73 mm

**100%
WORMPROOF**

TB 1500



TB 1500 DIMENSION

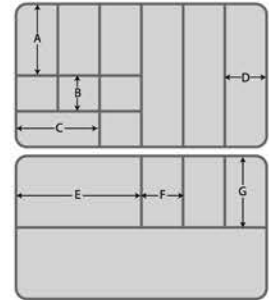

Outside dimensions

135 mm x 220 mm x 56 mm
A = 58 mm B = 28 mm C = 67 mm D = 33 mm
E = 101 mm F = 33 mm G = 58 mm

5 SPECIAL COLORS FOR ALL ITEMS:



TB 800



TB 450



TB 800 DIMENSION

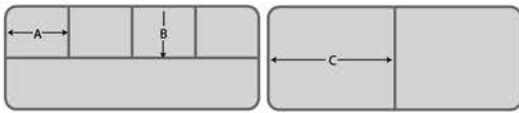

Outside dimensions

89 mm x 198 mm x 50 mm
A = 43 mm B = 35 mm C = 87 mm

TB 450 DIMENSION

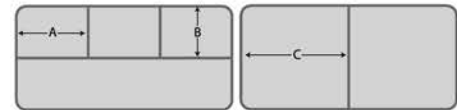

Outside dimensions

75 mm x 136 mm x 51 mm
A = 42 mm B = 30 mm C = 63 mm

TB 3000

ABOUT SLIDING LOCK SYSTEM

Instead of making just one big tackle box, Relix made two separate ones, that can be firmly attached together by a sliding lock system. This allows an angler to choose whether or not he wants to take all his tackle or just part of it, depending on the length of his fishing trip or the type of fishery he wants to practice at a given time. Supplied with replaceable dividers, to arrange the compartments to the angler's needs.

TB 3000 DIMENSION



Outside dimensions

213 mm x 260 mm x 107 mm
A = 27 mm B = 44 mm C = 42 mm

**Comes as a
set of 2**



**With dividers adjustable up to
24 compartments**

TB 400



TB 400 DIMENSION

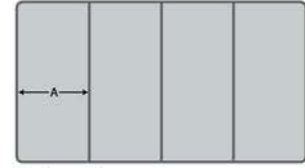

Outside dimensions
104 mm x 165 mm x 28 mm
A = 31 mm

TB 150



TB 150 DIMENSION



Outside dimensions
67 mm x 104 mm x 27 mm
A = 28 mm B = 20 mm

TB 650



With dividers adjustable up to
18 compartments



TB 270



TB 270 DIMENSION

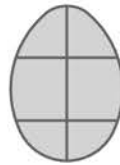

Outside dimensions
74 mm x 110 mm x 32 mm

TB 650 DIMENSION

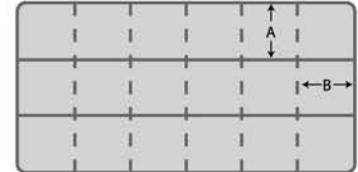

Outside dimensions
106 mm x 183 mm x 40 mm
A = 27 mm B = 27 mm

TB 280



TB 280 DIMENSION

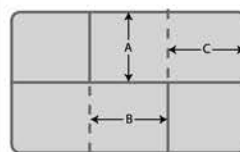

Outside dimensions
85 mm x 121 mm x 33 mm
A = 32.5 mm B = 43 mm C = 32 mm

5 SPECIAL COLORS FOR ALL ITEMS:



With dividers adjustable up to
6 compartments

**100%
WORMPROOF**

ABOUT ADJUSTABLE BOXES

Over time professional anglers gather an incredible amount of small tackles, such as hooks, swivels, beads, float stops, pieces of silicon tube, shrink tubes, sinkers, needles and so on. The list is endless. To organize all of those small tackles in an orderly and clear way, a big tackle box with many compartments can be a big relief. When supplied with replaceable dividers, as is the case with all the tackle boxes on this page, an angler can also easily change the number and sizes of the compartments. The Relix Adjustable Tackle Boxes are also very suitable for storing hard lures. Soft lures can also be safely kept in these boxes, as they are all 100% wormproof which means that draining softener (inside every soft lure) will never affect the plastic material.

TB 900



With dividers adjustable up to
15 compartments

TB 900 DIMENSION

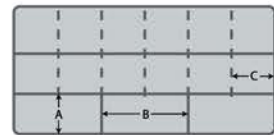

Outside dimensions

125 mm x 233 mm x 34 mm
A = 35 mm B = 72 mm C = 35 mm

TB 2200



With dividers adjustable up to
38 compartments

TB 2200 DIMENSION

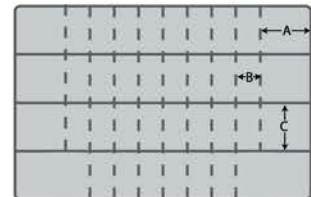

Outside dimensions

191 mm x 275 mm x 46 mm
A = 44 mm B = 19 mm C = 42 mm

TB 3700



With dividers adjustable up to
48 compartments

TB 3700 DIMENSION

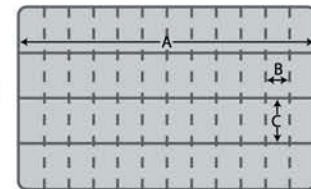

Outside dimensions

230 mm x 360 mm x 49 mm
A = 345 mm B = 28.5 mm C = 50 mm

5 SPECIAL COLORS FOR ALL ITEMS:

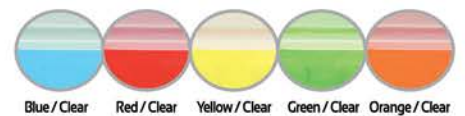

NEW



Kipit
LPC 880

Capacity 10 L / 333 OZ
Size: 310 x 250 x 195 mm



Multi KipBox
5L

Capacity 5 L
Size: 285 x 195 x 136 mm

STACKING NEST

STACKING WITHOUT LIDS

STACKING WITH LIDS

FOLDING CONTAINER

- Multi purpose smart folding container
- Tackle organizer
- Easy storage when not in use



Transparent

Black



Dimension/pc
20 cm x 15 cm x 9.2 cm

Dimension/pc
30 cm x 20 cm x 15.5 cm

ROD TUBE

LENGTH: 120 - 135 - 150 - 165 - 180 - 195



ReliX®
ROD TUBE

ABOUT RELIX ROD TUBE

Storing or travelling with rods safely has just been made easier with the range of rod tubes from ReliX.

The tubes can conveniently fit more than one rod at a time and include foam padding in the tip section to protect during transit or storage. All tubes also feature a secure locking system.

ROD RACK

AVAILABLE TYPES:



Horizontal



Vertical without header



Vertical with header



AVAILABLE COLORS:



- STORES 6 RODS NEATLY AND SECURELY
- FOAM GRIP PADS
- DURABLE AND LIGHTWEIGHT
- COMES IN BLACK, GREY, BLUE AND RED



RELIABLE FISHING TACKLE

OTHER BRANDS BY P.T. CENTRAL SARANA PANCING



www.carplinqfishing.com



www.catlinqfishing.com



www.relixnusantara.com

Mailing address and contact :

P.T. CENTRAL SARANA PANCING
Fishing reel and line manufacturer
Jl. Raya Serang Km. 12, Kawasan Industri Bunder No.88,
Kec. Cikupa, Tangerang 15710, Banten - INDONESIA

Phone : +62 21 5961265
Fax : +62 21 5961266
E-mail : sales@relixfishing.com
sales@centralsaranapancing.com

European Office:

Lucie Henton
Phone : +420 607 110 712
E-mail : lucie@henton.eu

TAIWAN

Yeuh Chung Enterprise.
1F no. 9 Lane 6 Cui Hua st.
Panchiao City, Taipei Hsien, Taiwan R.O.C.

INDONESIA

P.T. PERINTIS SARANA PANCING INDONESIA
Fishing hook manufacturer
Jl. Industri 69-A, T. Morawa B
Sumatera Utara - Indonesia

CHINA

Quanzhou Anxi Sanxiu Fishing Gear Co. Ltd.
Swivel manufacturer
Tulou Village, Chengxiang Town, Anxi,
Quanzhou, Fujian, China

Quanzhou Heng Feng Fishing Tackle Co.,Ltd
Fishing hook manufacturer
Heshi Industrial Zone,
Luojiang District Quanzhou -362013
Fujian Province, China